

Technical Manual

Aluminium wheel machining

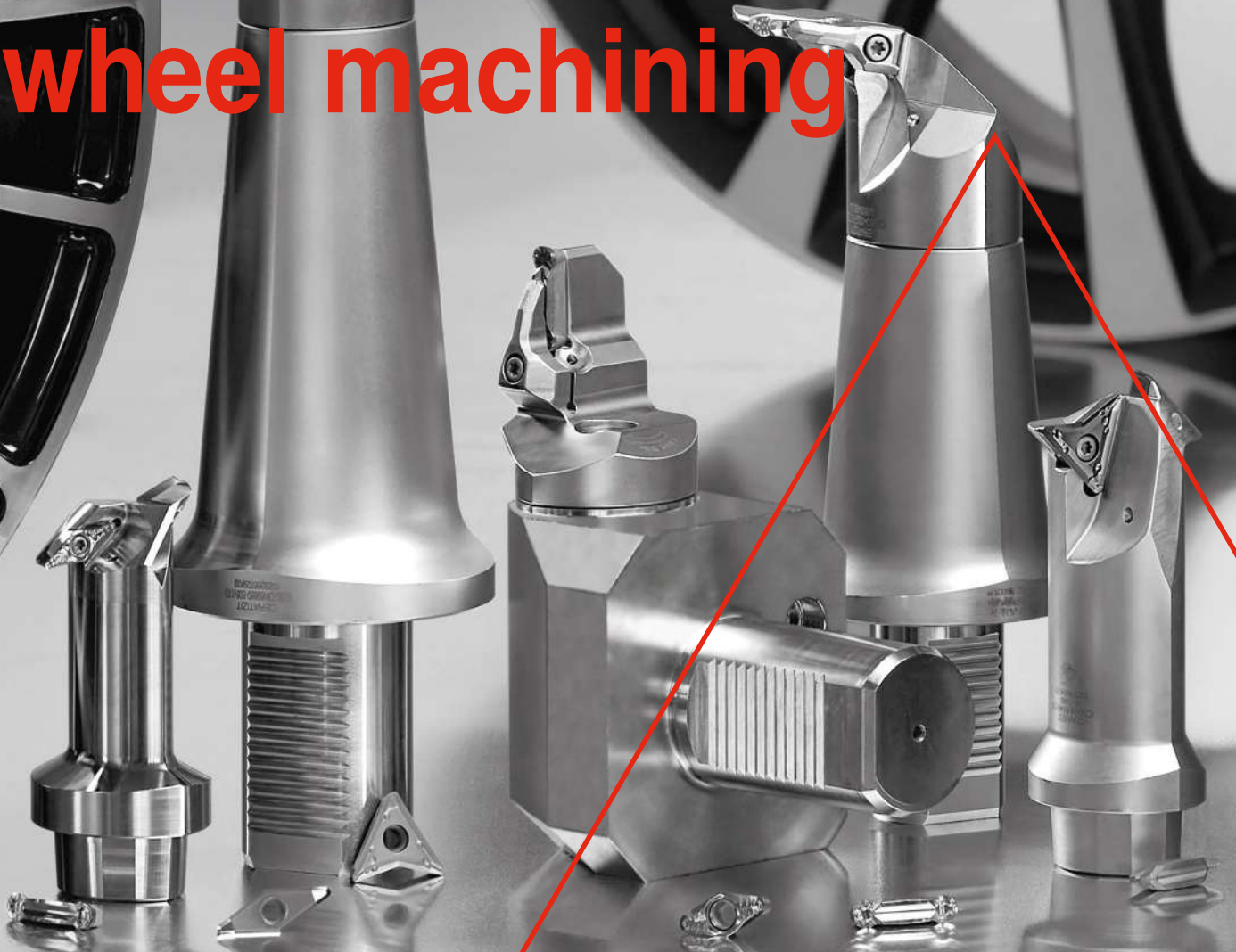

CERATIZIT is a high-tech engineering group specialising in tool and hard materials technologies.

Tooling the Future

www.ceratizit.com

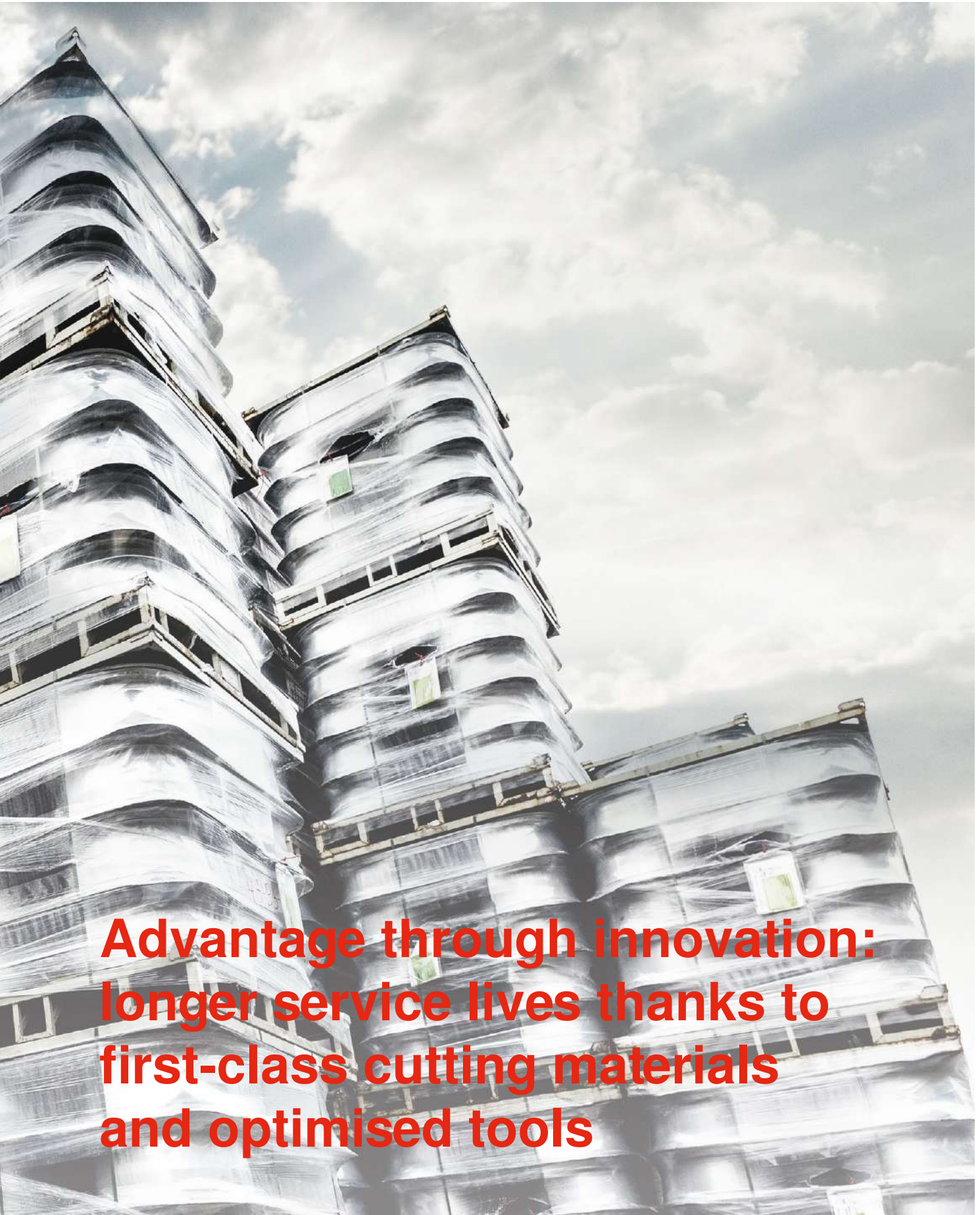

**Advantage through innovation:
longer service lives thanks to
first-class cutting materials
and optimised tools**

Dear customers,

Since 1983, CERATIZIT has been a leader in aluminium wheel machining, and active as a full-service provider in that field. Over the course of the years, the carbides expert has extended its range of tools and optimised the grades and indexable inserts it offers. This means that CERATIZIT is able to provide the ideal tool for any operation – including inside and outside profiles, and valve and screw hole bores. Aluminium wheels of cars, motorbikes, HGVs and even aeroplanes can be machined in a precise manner.

More than 50 percent of all aluminium wheels are machined using CERATIZIT tools. Time for the company to rest on its laurels? Certainly not! CERATIZIT is continually focused on new technologies and services, and takes on all challenges so that it can improve still further.

Your Cutting Solutions by CERATIZIT team





Contents

▲ CERATIZIT GROUP	6-7
▲ QUALITY	8-9
▲ LOGISTICS	10-11
▲ CERATIZIT SERVICES	12-13
▲ ALUMINIUM WHEEL MACHINING	14-15
▲ MACHINING COMPETENCE	16-17
▲ OVALFLEX SYSTEM	18
▲ UTS/MAXILOCK S SYSTEM	19
▲ OVALFLEX / HUBSTAR	20-28
▲ PCD INDEXABLE INSERTS	29
▲ GRADES OVERVIEW	30-31
▲ CHIP BREAKERS	32-35
▲ RANGE OF INDEXABLE INSERTS	36-50
▲ OVALFLEX RANGE	52-70
▲ RANGE OF TOOL HOLDERS / BORING BARS	72-89
▲ DRILLING RANGE	90-92
▲ MACHINE CONNECTIONS	94
▲ SPECIAL TOOLS	95
▲ TECHNICAL REFERENCES	96-100
▲ OEM SERVICES	101-104



CERATIZIT – your competent partner for innovative hard material solutions, highly specialised cutting tools and a worldwide service network

The CERATIZIT Group

CERATIZIT – with passion and pioneering spirit for carbides

For more than 95 years, CERATIZIT has been a pioneer in the field of ambitious hard material solutions for machining and protection against wear. The private company, with registered offices in Mamer, Luxembourg, develops and produces highly specialised cutting tools, indexable inserts, rods made from hard materials and wearing parts. The CERATIZIT Group is the global market leader in various application segments for wearing parts and is successfully developing new carbide, cermet and ceramic grades, for example for woodworking and stone working.

With more than 9,000 employees at 34 production facilities worldwide and a sales network with over 70 branches, CERATIZIT is a global player in the carbide sector. The

technology leader is constantly investing in research and development and holds more than 1,000 patents. Innovative carbide solutions from CERATIZIT are used in mechanical engineering and tool making, in the automotive industry, the aviation and aerospace industry, and in the medical industry.

The CERATIZIT Group is active internationally and unites the four flagship brands Cutting Solutions by CERATIZIT, Hard Material Solutions by CERATIZIT, Tool Solutions by CERATIZIT and Toolmaker Solutions by CERATIZIT. The carbide manufacturer also owns the WNT and CB-CERATIZIT subsidiaries, as well as the tool manufacturers Günther Wirth, PROMAX Tools, Klenk, Cobra Carbide India, Becker Diamantwerkzeuge, Best Carbide Cutting Tools and KOMET GROUP.

Facts & figures

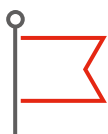

1 headquarters
Mamer, Luxembourg

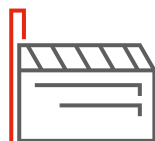

34
production facilities



> 70
sales offices



> 9,000
employees



> 100,000
different products



> 1,000
patents and utility models



> 200
employees in R&D



> 10
innovation prizes



30%
of products less than 5 years
old



**Modern machines,
experienced specialists
and the mastery
of the entire process chain
guarantee
outstanding product quality
and reliable processes**

Always the best quality

Cutting Solutions by CERATIZIT is a quality leader that unites all of the process knowledge and the extensive manufacturing competences of the CERATIZIT Group.

- ▲ Highly qualified, trained experts in a wide range of areas.
- ▲ We control each individual production step.
- ▲ Our modern fleet of machinery is constantly being

expanded and improved.

- ▲ Optimised production processes reduce process costs and ensure that our products are of the very highest quality, as well as being environmentally friendly.
- ▲ Independently tested and certified products.



Preparing and mixing the powder

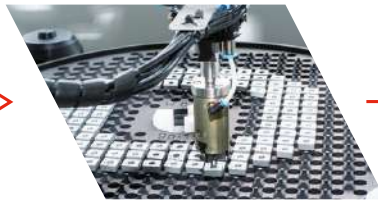

Shaping / Pressing



Sintering



Grinding



Dispatch



Recycling



**Well thought-out logistics processes,
a global sales network
and flexible, high production
capacities guarantee rapid and
reliable
delivery of your product solutions**

Optimum availability

The majority of our standard products are available from stock. Our well organised warehouse guarantees that your order will be processed quickly and reliably, even if it is for large quantities. Thanks to our modern supply chain management, our production capacities are flexible. We are

therefore able to manufacture very large quantities in a very short period of time.

You can order products that are in stock from our online e-techstore, 24 hours a day.



e-techstore.com
Available for you
24 hours a day



The benefits for you:

- ▲ Live check on product availability
- ▲ Comprehensive technical details and graphical representations
- ▲ Rapid delivery: For orders placed before 6.30 pm, the goods are dispatched from our warehouse in Kempten, Germany on the same day.
- ▲ Adherence to deadlines: We work exclusively with the best and most reliable transport service providers in the industry

CERATIZIT service

Online service

Of course, we are also here for you online – 24 hours a day! On the CERATIZIT website, you will not only find all the details on our innovative products, but can also order these products straight away. Within the various product ranges, you have access to over 80 product details pages from the fields of machining, rods & moulded parts, wear protection and wood & stone working. Discover product videos, application examples and success stories.

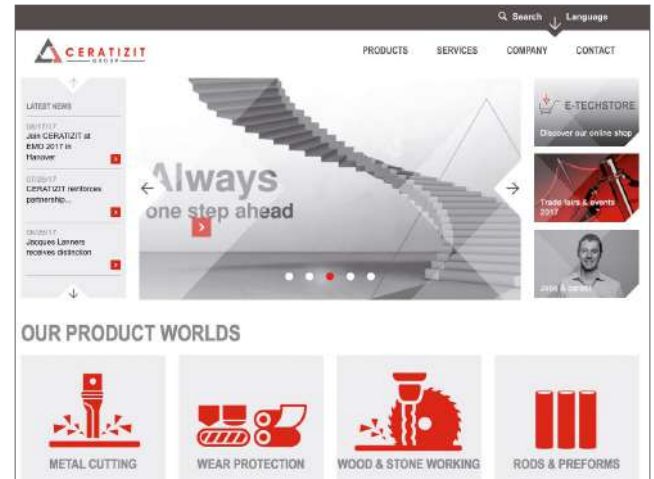

Connection to your system

Would you like to connect your ERP system to our shop, for example? No problem! Please do not hesitate to contact our e-commerce team. Our IT supports all common connection formats (EDI, XML, OCI, etc.). Just get in touch! Working

together with you, our engineers will analyse the prerequisites and advise you on selecting the correct technology.

Restore service

Re-grinding service for standard, semi-standard and special tools. Place your trust in the world-renowned and consistently high product quality of Cutting Solutions by CERATIZIT and the reliable service. This also includes re-grinding of solid carbide tools. Naturally, the prices for our restore service are

also calculated fairly and transparent.

Configure

Your tailor-made tool. Using the Configure online solution, a tailor-made semi-standard tool can be configured with just a few clicks of the mouse. With the new Configure tool, we offer you a quick and easy ordering process for solid carbide tools adapted to individual customer's requirements. In our e-techstore, you can create your tailor-made semi-standard tool with just a few clicks of the mouse – 24 hours a day, seven days a week!



Tooling Academy

In addition, familiarise yourself with how the tools will work in your applications, right down to the details – on machines like those in use in all production facilities today. To enable this, we have set up test and training centres with cutting-edge machines and the very latest analysis technology in our Tooling Academy.

Working together with you, we investigate the workability of the materials and tools. Based on the findings from simulations and practical tests, we then draw up specific tool recommendations or develop specific tool solutions for you.



Complete range Cutting tools



Download from
www.ceratizit.com

Aluminium wheel machining

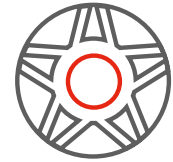

Cutting Solutions by CERATIZIT: the leader in aluminium wheel machining

The machining of aluminium wheels requires high cutting speeds and extremely hard cutting materials. Enormous centrifugal forces are generated and make it necessary to use stable tools that are able to withstand the high rotational speeds and loads. Cutting Solutions by CERATIZIT has decades of knowledge and experience in this segment, and has consistently expanded and optimised its range of tools and indexable inserts. We

are now full-service providers: we are able to offer the optimal tool for every process involved in the production of aluminium wheels – from machining the inside and outside profiles through to valve and screw hole bores. Today, tools from Cutting Solutions by CERATIZIT are used to machine around 50% of all aluminium wheels found on cars, motorbikes, HGVs and aeroplanes.

PCD machining

Cutting Solutions by CERATIZIT is constantly investing in the initial and further development of cutting materials, and has by far the largest PCD range for aluminium wheel machining. Combined with current manufacturing technology, PCD indexable inserts guarantee optimal consistency and repeatability of the service life. The large number of variants offer the right chip breakage and optimal machining power for any application.



OvalFlex Strong

The requirements made of the machining power of our tools by aluminium wheel customers are increasing. We have responded to this and, in collaboration with them, have developed OvalFlex heads offering maximum stability. The strengthened OvalFlex variants OC50S-... (power screw) and OC50RS-... (radial clamping) are optimised for use with the X32-R4.00... insert series and enable a higher chip removal rate.



HubStar variable

The greatest opportunity for saving time in aluminium wheel machining is in the area of the hub. The HubStar range (diameters between 48–75 mm) is designed to drill out the hub in one step with maximum feed, to the required diameter, while the same tool can then be used to turn the face contact and the hub contour.



Full-carbide standard range

Cutting Solutions by CERATIZIT is the first manufacturer of cutting tools for the holes in aluminium rims to have standardised its range, due to the high level of technical success we have achieved. The high-quality base material, combined with the new coating, enables service lives that are up to four times higher than the competitors' products. In addition, the full-carbide products can be reground at least three times.



Machining competence



External machining





Internal machining



Internal machining of mating surface



Undercut



Hub machining



Mirror machining



Drilling

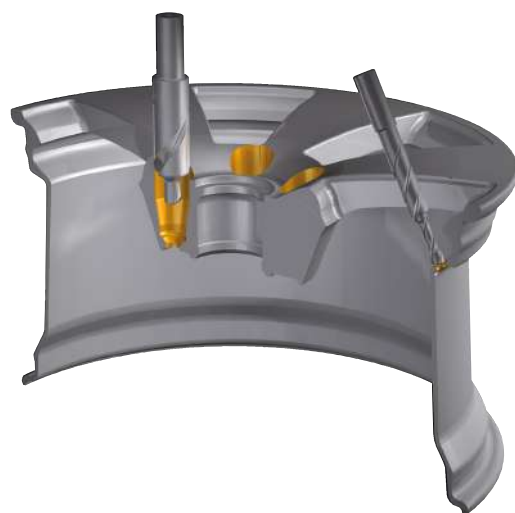

OvalFlex system

The OvalFlex system is tailormade for producing aluminium wheels with its specific machines. It has been completely optimised, from the cutting edge to the machine connection.

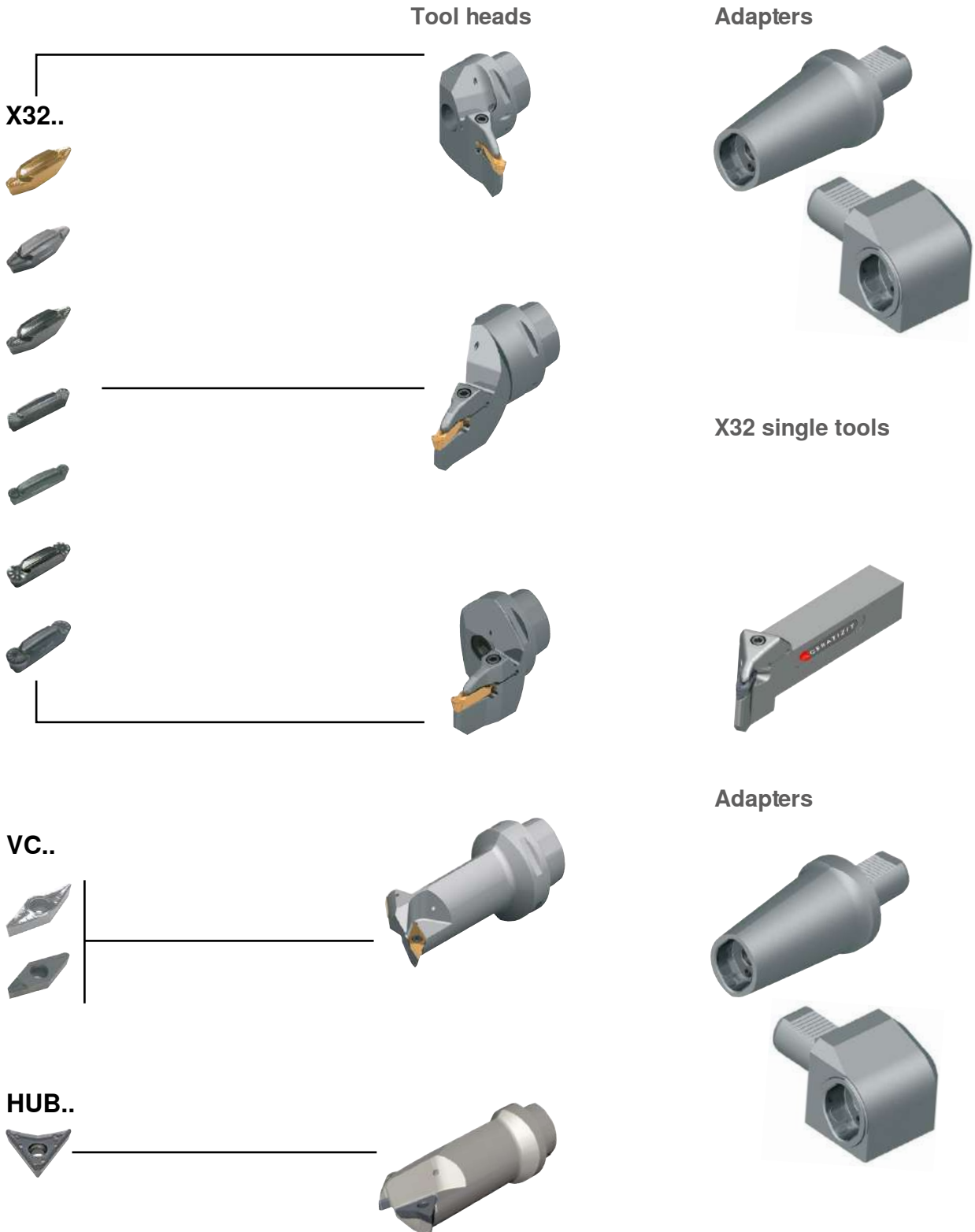

UTS/MaxiLock S system

The UTS and MaxiLock S tool systems have proven their worth over many years, and are characterised by high flexibility with a range of machine types.

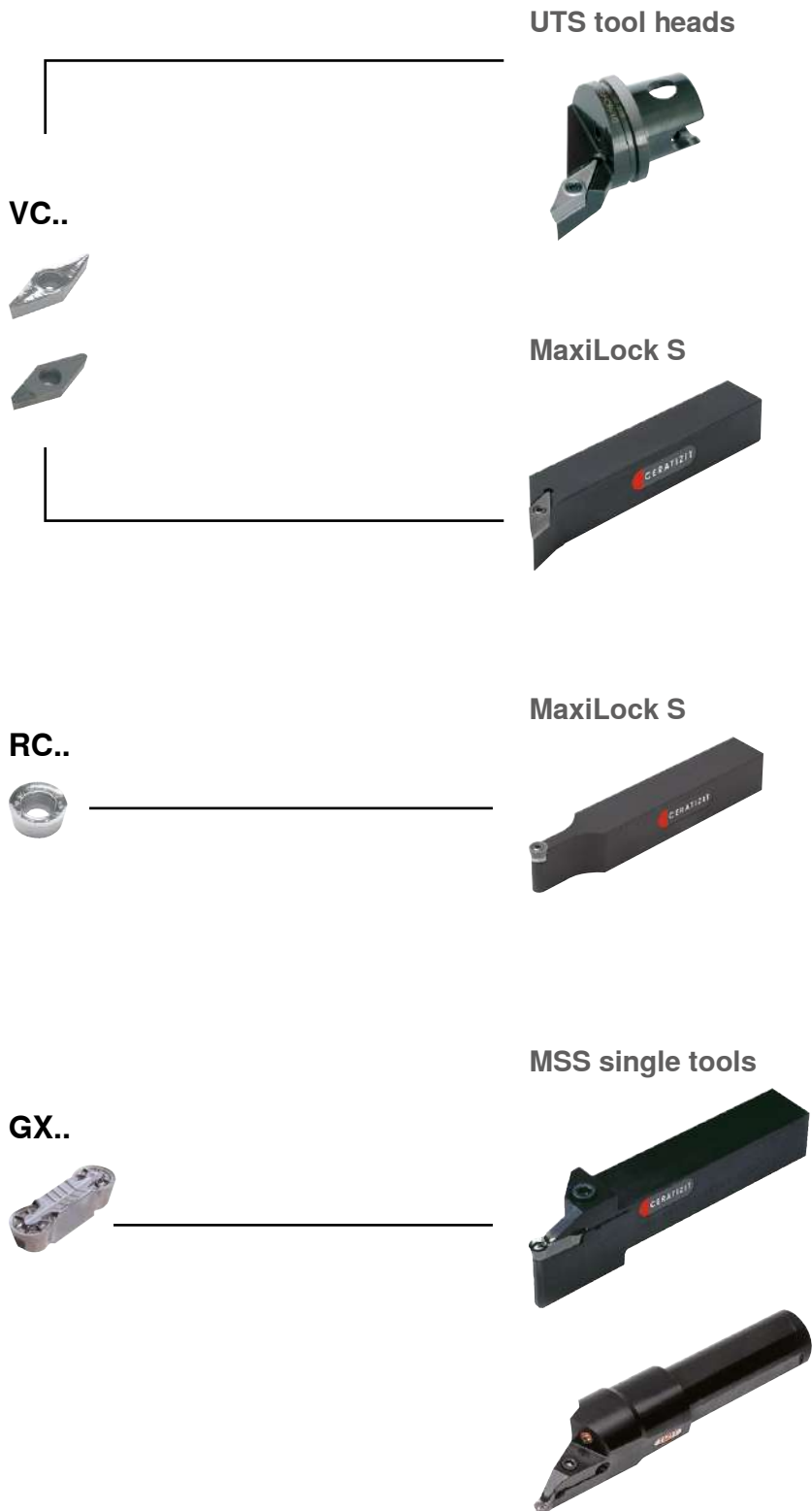

OvalFlex

System description

OvalFlex is a modular tool system for machining the entire aluminium wheel. Depending on the indexable insert, users are able to machine the outside and inside profiles, the face contact, the hub profile and the visible surfaces. Moreover, OvalFlex is flexible and can be adapted to any rim type.

The oval and conical design increases the stability and performance compared with conventional, round tools. This means that aluminium wheels can be machined with high cutting values. In addition to an axial version, CERATIZIT also offers a version with radial clamping.

Comparison: conventional clamping and OvalCoupling

Conventional clamping

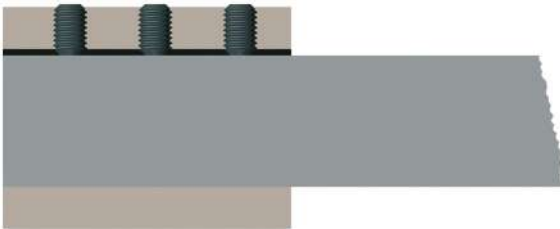

- ▲ Play between cylindrical shaft and locating bore.
- ▲ Unstable connection
- ▲ Point or line clamping

Boring bar adapter

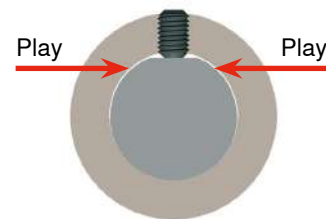

OvalCoupling (OC)

Optimum stability with the "OvalCoupling" (OC) connection

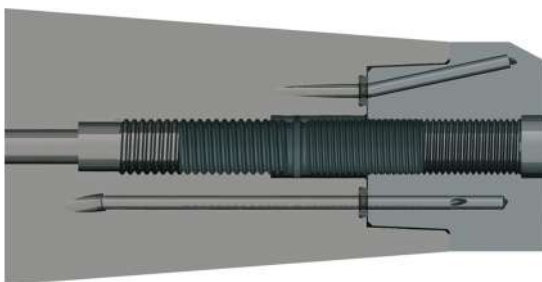

OvalCoupling (OC)

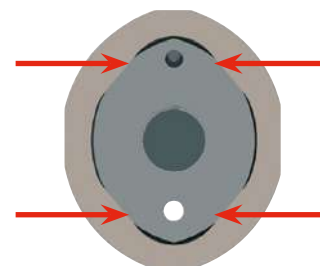

- ▲ Radial positioning due to **four conical mating surfaces**.
- ▲ Axial positioning due to **conical mating surfaces** and **face contact**.
- ▲ Connection with absolutely no play.

OvalFlex Axial (power screw):

The question of whether to choose OvalFlex Axial or Radial is best answered by looking carefully at your production process.

Power screw clamping is ideal for use where varying forces are applied, i.e. the depths of cut fluctuate strongly, the

strength of the person changing the tools fluctuates greatly, etc. In summary, where many influencing factors that cannot be coordinated are present within your production process. With a well-optimised production process, including well-trained personnel, OvalFlex Radial is the better choice.

- ▲ Easy to use
- ▲ High stability due to M16 power screw
- ▲ Protected against emulsion and swarf inside the adapter
- ▲ High contact pressure with 50 Nm torque



OvalFlex Radial

OvalFlex Radial guarantees a high level of flexibility, particularly in areas where the aluminium wheel design and dimensions change frequently. CERATIZIT developed radial clamping so that changing tools between the individual machining steps does not take too long and can be carried

out directly in the machine. This means that various tool heads can easily be attached to the base adapters. OvalFlex Radial is ready for use again within eight seconds.

- ▲ Good accessibility due to radial clamping
- ▲ Easier changing of the OvalFlex heads in the machine
- ▲ Only approximately 3 turns with 25 Nm torque
- ▲ Head change instead of insert change (approx. 8 seconds required for change)



Characteristics/Advantages

X32 indexable insert – insert seat

- ▲ Significantly larger indexable insert that can withstand higher stresses
- ▲ Conical roof surfaces for optimal pull-out protection
- ▲ Better positioning of the insert due to 30° roof surfaces
- ▲ Conical middle part for wider indexable inserts

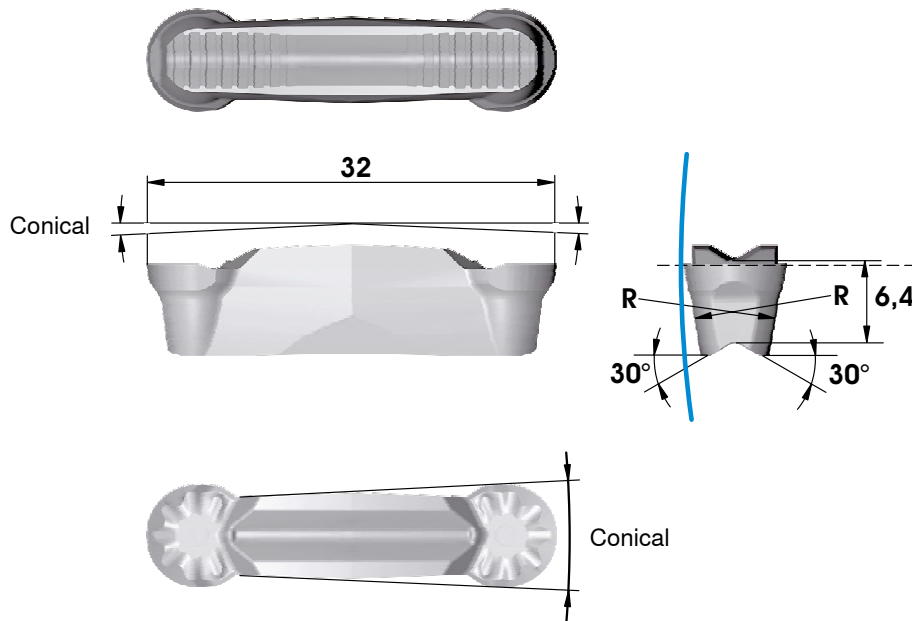

X32 indexable insert – clamping

- ▲ Clamping with pull-out protection for the indexable insert
- ▲ Insert is optimally positioned in the tool thanks to 30° roof surfaces
- ▲ Conical-shaped grooving tracks for improved stability
- ▲ 3-point clamping

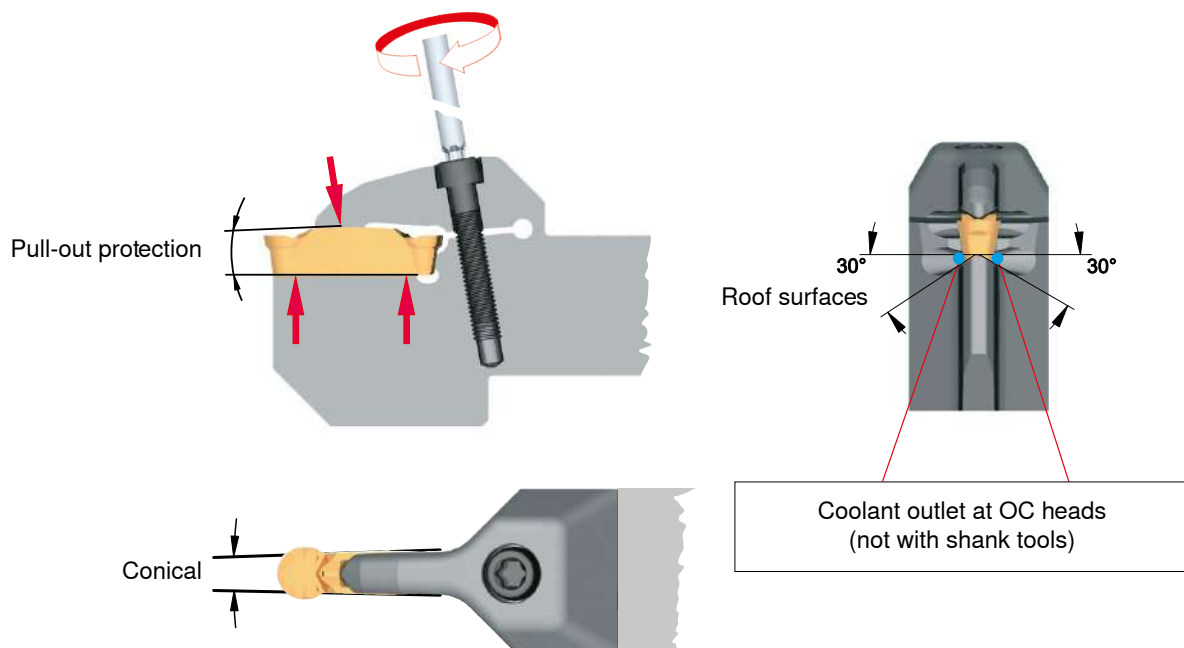

Tool – normal variant

Significantly larger indexable insert that can withstand higher stresses.

Conical roof surfaces for optimal pull-out protection.

- ▲ High degree of freedom for great flexibility
- ▲ Side pockets for easier changing of insert
- ▲ All X32 inserts can be used in the same OvalFlex head (R1.6, R2.0, R3.0, R4.0)
- ▲ Reduced stock requirements due to large standard range

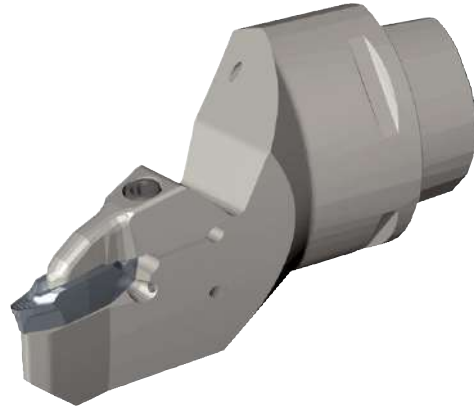

Tool – strengthened variant

The requirements of aluminium wheel customers concerning the machining power of our tools are growing, and the need to bring OvalFlex heads with maximum stability onto the market led to the OC50S-... (power screw) and OC50RS-...

(radial clamping) variants. These strengthened OvalFlex heads are optimised for use with the X32-R4.00... series of inserts, making it possible to increase the material thickness.

Customer benefits / Sales arguments

- ▲ Higher machining power
- ▲ Lower wear on the OvalFlex heads
- ▲ Side pocket for easier changing of insert
- ▲ More stable service life due to coolant supply in the finger
- ▲ Power screw and radial clamping variants available

Success factors

- ▲ Stronger clamping finger with thro' coolant supply
- ▲ Thickness and depth of support increased (use only with inserts of 4 mm radius)
- ▲ M6 screw for greater clamping force
- ▲ Larger mating surface



OvalFlex HubStar

System description

HubStar

The greatest opportunity for saving time in aluminium wheel machining lies in the area of hubs with a diameter of >60 mm. In general, the rough diameter after counterboring or punching out measures 40–45 mm. In order to obtain a larger diameter, the part is normally opened up to the required diameter using a V-insert, in multiple steps (in some cases it is also counterbored, with a tool change being necessary).

The HubStar range has been designed to drill out the hub in one step with maximum feed, to the required diameter, while the same tool can then be used to turn the face contact and the hub contour. Here, time savings of up to 65 seconds per aluminium wheel are possible.

Conventional machining

Multiple cuts

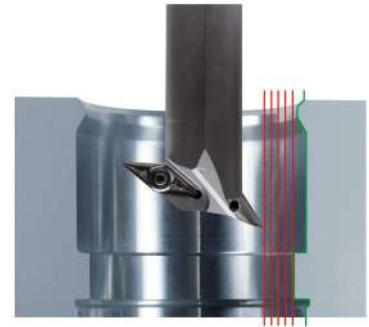

OvalFlex HubStar

Now in one step to the required diameter

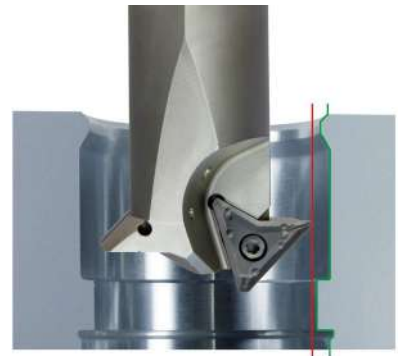

Cut distribution

Due to the special layout of the indexable insert, the cut and therefore the force are distributed during counterboring, enabling vibration-free machining with maximum feed.



Indexable insert

The extremely-stable HUB 1507QR-27 indexable insert was developed especially for hub machining of aluminium wheels. The insert has appropriate geometry and radii for each specific application:

- ▲ Radius R 0.8 mm: Machining the hub cap seat
- ▲ Radius R 1.2 mm: Machining the inside profile
- ▲ Radius R 1.6 mm: Turning the face contact
- ▲ (higher feed possible)

Each of these radii has a finishing cutting edge that produces perfect surfaces at high feed rates.

R 1,2 mm R 0,8 mm



R 1,6 mm

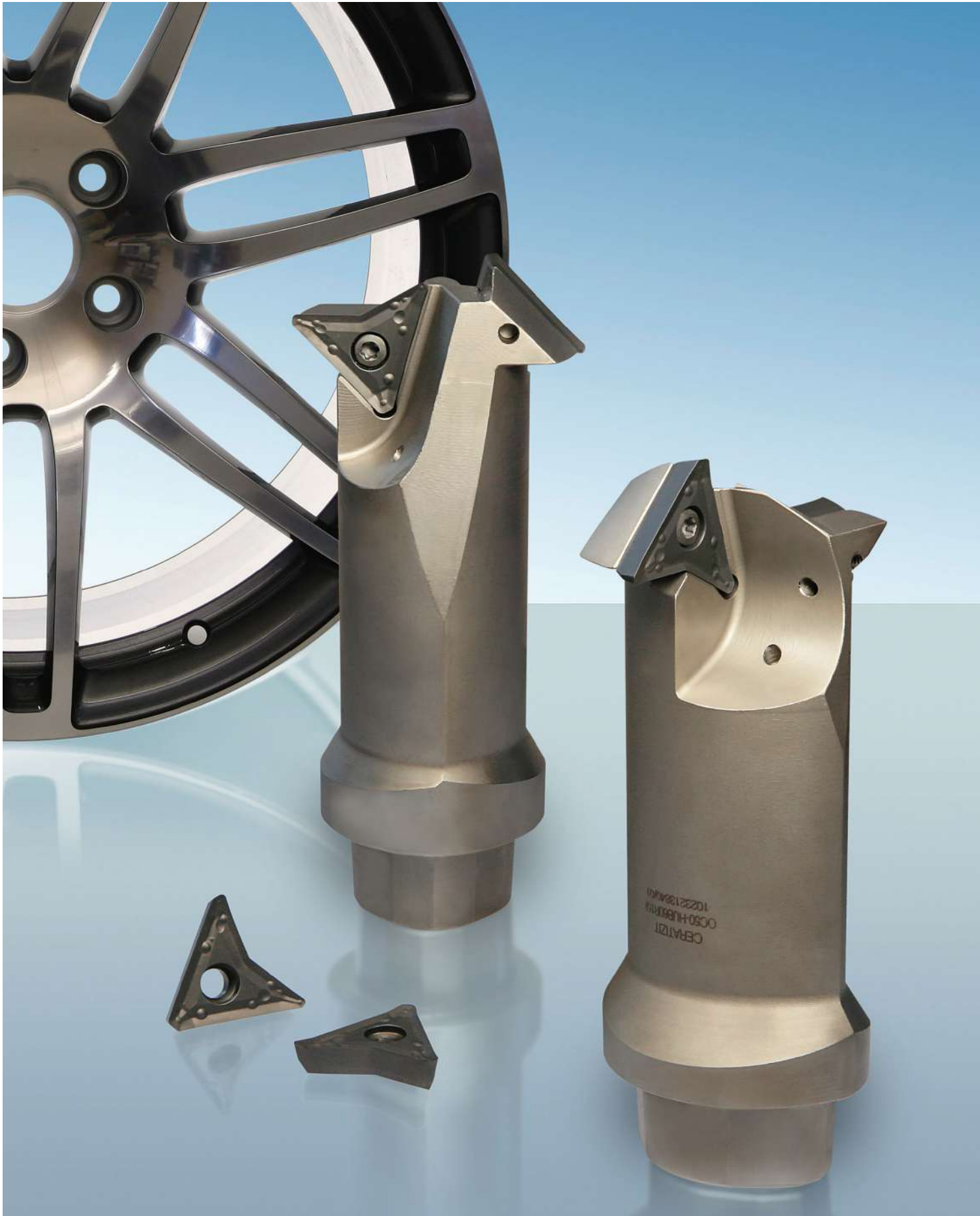

Assembly with axial clamping

The tried-and-test OvalFlex Axial is characterised by its stability. It is the optimal solution for applications that require fewer tool changes.

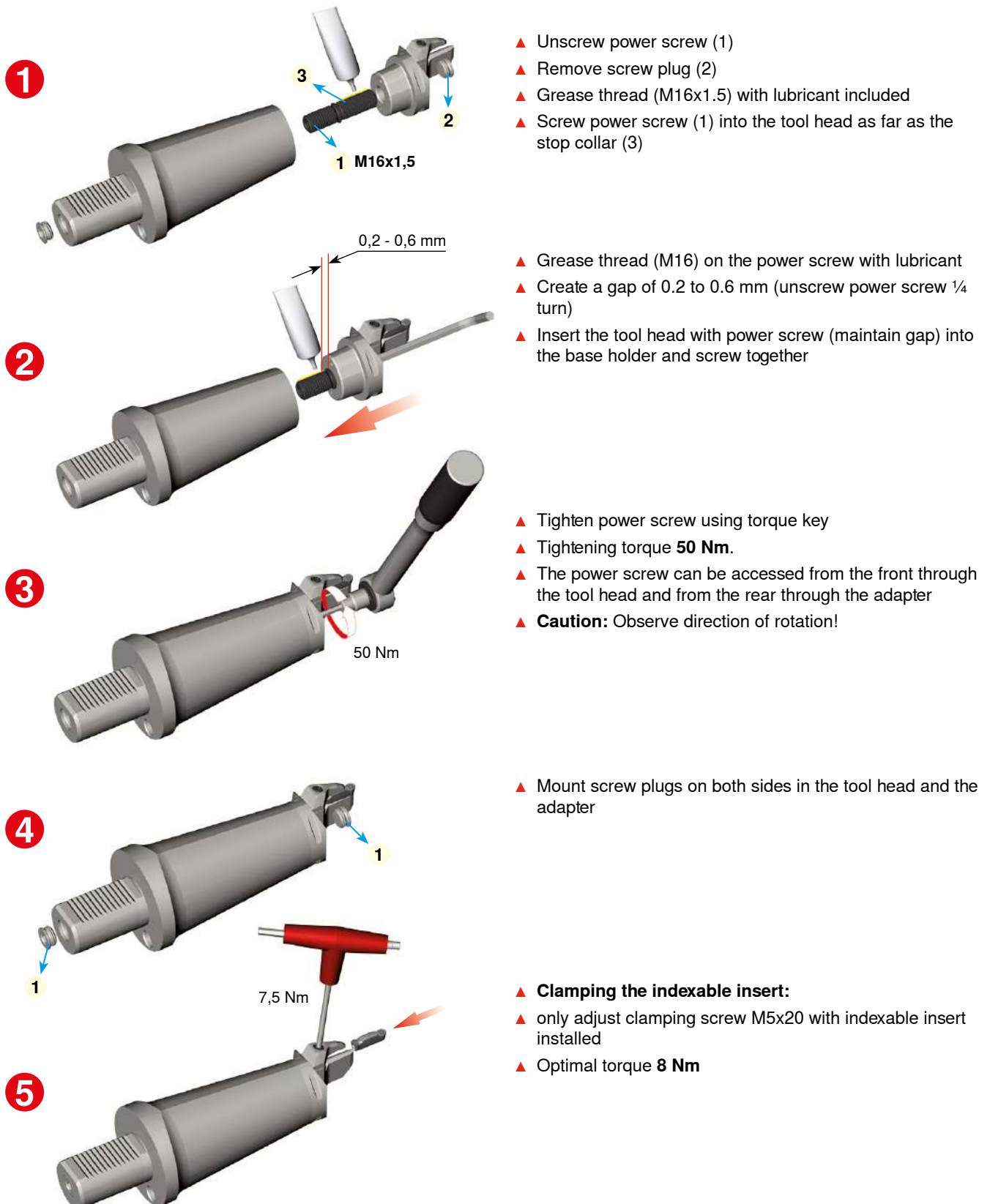

- ▲ Unscrew power screw (1)
 - ▲ Remove screw plug (2)
 - ▲ Grease thread (M16x1.5) with lubricant included
 - ▲ Screw power screw (1) into the tool head as far as the stop collar (3)
- ▲ Grease thread (M16) on the power screw with lubricant
 - ▲ Create a gap of 0.2 to 0.6 mm (unscrew power screw ¼ turn)
 - ▲ Insert the tool head with power screw (maintain gap) into the base holder and screw together
- ▲ Tighten power screw using torque key
 - ▲ Tightening torque **50 Nm**.
 - ▲ The power screw can be accessed from the front through the tool head and from the rear through the adapter
 - ▲ **Caution:** Observe direction of rotation!
- ▲ Mount screw plugs on both sides in the tool head and the adapter
- ▲ **Clamping the indexable insert:**
 - ▲ only adjust clamping screw M5x20 with indexable insert installed
 - ▲ Optimal torque **8 Nm**

Assembly with radial clamping

The tool change takes place directly in the machine.
Different tools are attached to the adapters with minimum effort.

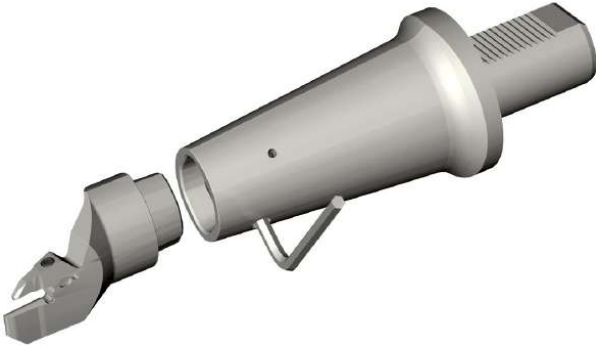
1

▲ Close clamping jaws and slightly loosen again

2

▲ Insert head

3

▲ Tighten to 25 Nm using torque key
▲ Determine direction of rotation based on the symbol on the side to be actuated

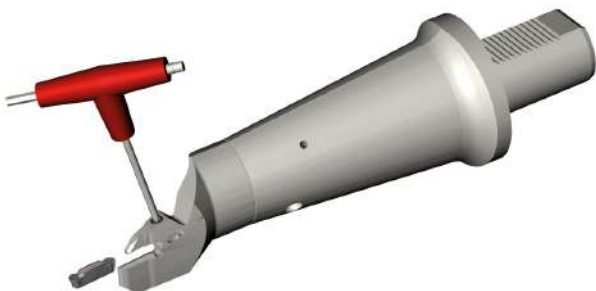
4

▲ Only tighten clamping screw M5x20 with indexable insert installed
▲ Optimal torque 8 Nm

OvalFlex coolant supply

In machining, coolants are primarily used for cooling, lubricating and chip evacuation. Flood coolant is still the most widely used.

However, even the best coolant is of no use if it does not reach the cutting edge. We are confronted with this problem during grooving or parting off in particular, as the cutting edge is completely shielded during this process.

Tools with targeted thro' coolant are opening up new

opportunities for increasing productivity.

In the OvalFlex tool system, all coolant holes are optimised for this targeted thro' coolant.

This gives the following advantages:

- ▲ Outlet holes optimised for MMS and emulsion
- ▲ Coolant is available extremely quickly thanks to bore that is as straight as possible
- ▲ Three coolant outlets, therefore better coolant and chip clearance
- ▲ With the OC50..S.. tools, thro' coolant also runs through the clamping finger



PCD indexable inserts

The new generation of PCD

With the further-developed cutting materials and chip breakers from CERATIZIT, it is possible to machine the whole aluminium wheel – even with interrupted cuts. The new generation consists of a wide range of indexable inserts: 300 different PCD inserts, shapes, chip breakers and cutting edges offer the optimal solution for all machining steps.



What qualities characterise the new PCD generation?

- ▲ High process security
- ▲ Reduced production times
- ▲ High tool life
- ▲ Controlled chip breakage
- ▲ High surface quality
- ▲ Low cutting forces



Why is turning with a single-sided PCD segment more cost-effective?

- ▲ Longer segment – greater depth of cut
- ▲ Stable base plate
- ▲ Consistent service life
- ▲ High process security with high cost-effectiveness
- ▲ In left-handed and right-handed versions
- ▲ All chip breakers are available with a single-sided segment

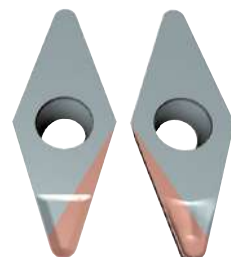

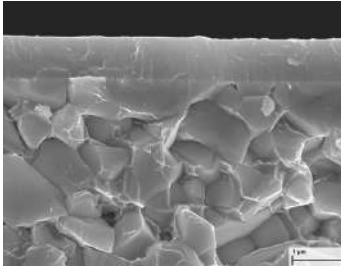
AMZ

HC-N10 | HC-P10 | HC-K10

**Specifications:**

Composition: Co 6%; WC balance | Grain size: 1 μm | Hardness: HV₃₀ 1630
| Layer system: PVD TiAlN

Recommended use:

The coated carbide grade for aluminium machining.

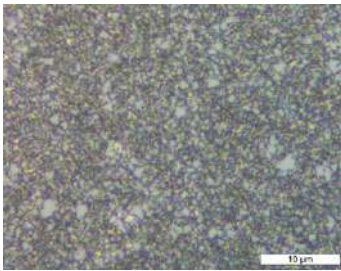
H210T

HW-N10 | HW-S10 | HW-K10

**Specifications:**

Composition: Co 6.0%; WC balance | Grain size: 0.8 μm | Hardness: HV₃₀ 1850

Recommended use:

The wear-resistant, uncoated carbide grade for machining aluminium and other non-ferrous metals.

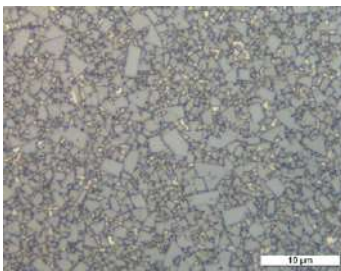
H216T

HW-N15 | HW-K15

**Specifications:**

Composition: Co 6.0%; WC balance | Grain size: 1 μm | Hardness: HV₃₀ 1630

Recommended use:

The uncoated carbide grade for machining aluminium and other non-ferrous metals.

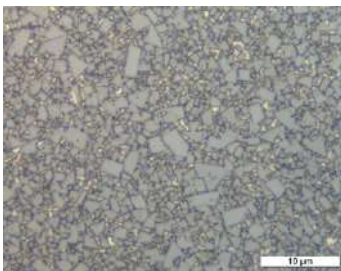
H10T

HW-N15 | HW-K15

**Specifications:**

Composition: Co 6.0%; WC balance | Grain size: 1 μm | Hardness: HV₃₀ 1630

Recommended use:

The uncoated carbide grade for machining aluminium and other non-ferrous metals.

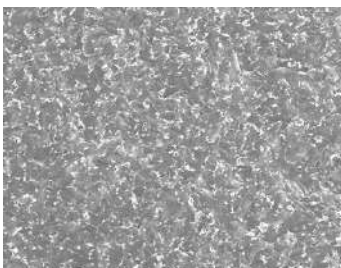
CTD4110

DP-N05

**Specifications:**

Composition: Polycrystalline diamond (PCD) | Grain size: ~ 5 μm

Recommended use:

Polycrystalline diamond grade for machining of non-ferrous metals and non-metallic materials.

Chip breakers

-23P



- ▲ Low adhesion
- ▲ Good chip control with soft aluminium alloys

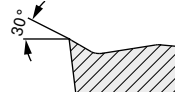
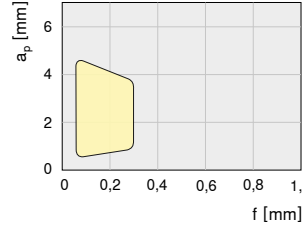

CCGT 09T308..





Machining conditions

		
H216T	H216T	H216T

-25Q

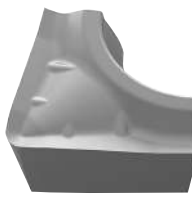

- ▲ Masterfinish geometry
- ▲ High feeds
- ▲ High surface quality
- ▲ Good chip control with softer aluminium alloys
- ▲ Low adhesion

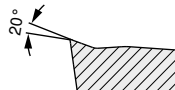
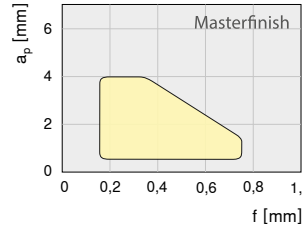

CCGT 09T308..





Machining conditions

		
H210T		
H210T	H210T	
H210T	H210T	
H210T	H210T	H210T
H210T	H210T	

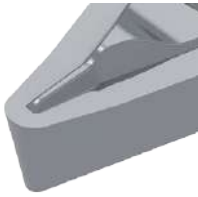

-24P

- ▲ For machining of forged aluminium with less than 1% silicon, non-ferrous metals, plastics and refractory metals
- ▲ In the mid-area through to roughing
- ▲ Good chip breakage for a wide application range

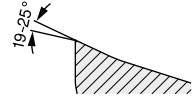
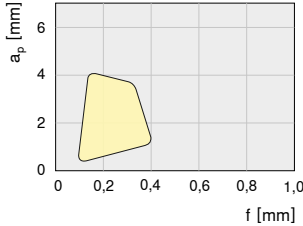

VCGT 160412..

Machining conditions		
		
H210T, H216T	H210T, H216T	H210T, H216T



-25P

- ▲ Sharp cutting edge
- ▲ Good chip control with softer aluminium alloys
- ▲ Low adhesion

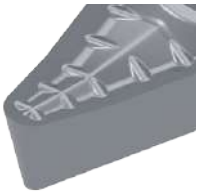

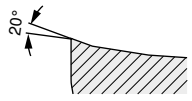
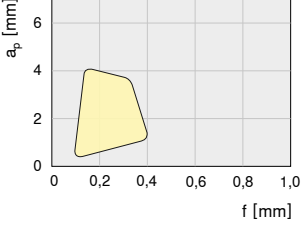
VCGT 160412..

Machining conditions		
		
AMZ	AMZ	
AMZ	AMZ	
AMZ	AMZ	
H210T	H210T	H210T
AMZ	AMZ	



-27

- ▲ The universal aluminium geometry
- ▲ Sharp cutting edge
- ▲ Extremely positive rake angle
- ▲ Low adhesion
- ▲ High feeds

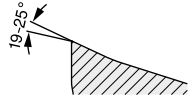
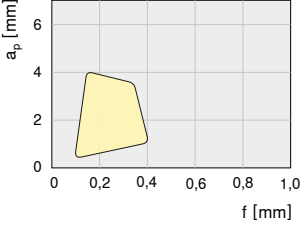

VCGT 160412..

Machining conditions		
		
AMZ	AMZ	
AMZ	AMZ	
AMZ	AMZ	H10T
H10T	H10T	H10T



-28P



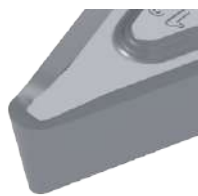

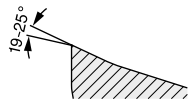
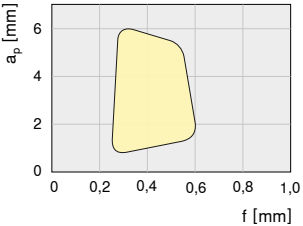
- ▲ The universal aluminium geometry
- ▲ Sharp cutting edge
- ▲ Extremely positive rake angle
- ▲ Low adhesion
- ▲ High feeds





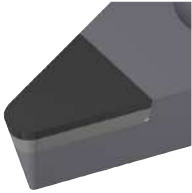



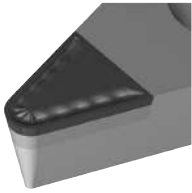

VCGT 160412..









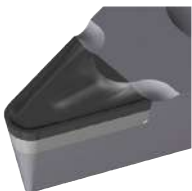

Machining conditions		
		
H210T, H216T	H210T, H216T	H210T, H216T



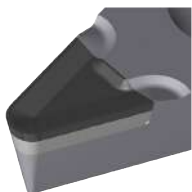

<p>-F4</p> <ul style="list-style-type: none"> ▲ PCD segment without chip breaker ▲ Predominantly used with interrupted cut ▲ Cutting edge finish available: sharp (F), rounded (E), chamfered (T) in line with ISO designation system 		Machining conditions		
				
		CTD4110	CTD4110	CTD4110

<p>-F41</p> <ul style="list-style-type: none"> ▲ PCD segment ▲ Chip-breakage optimised chip breaker for small cutting depths ▲ Cutting edge finish available: sharp (F), rounded (E), chamfered (T) in line with ISO designation system 		Machining conditions		
				
		CTD4110	CTD4110	CTD4110

<p>-M4</p> <ul style="list-style-type: none"> ▲ PCD segment with carbide pin for improving chip breakage with greater cutting depths ▲ Cutting edge finish available: sharp (F), rounded (E), chamfered (T) in line with ISO designation system 		Machining conditions		
				
		CTD4110	CTD4110	CTD4110

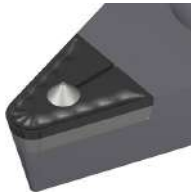
<p>-M41</p> <ul style="list-style-type: none"> ▲ PCD segment with tried-and-tested M41 chip breaker ▲ Optimised chip breaker for low cutting pressure and ideal chip shape ▲ Cutting edge finish available: sharp (F), rounded (E), chamfered (T) in line with ISO designation system 		Machining conditions		
				
		CTD4110	CTD4110	CTD4110

<p>-R41</p> <ul style="list-style-type: none"> ▲ PCD segment with R41 chip breaker ▲ Roughing stage for pre-machining with up to 4 mm depth of cut ▲ Cutting edge finish available: sharp (F), rounded (E), chamfered (T) in line with ISO designation system 		Machining conditions		
				
		CTD4110	CTD4110	CTD4110

<p>-U41</p> <ul style="list-style-type: none"> ▲ PCD segment with U41 chip breaker ▲ Universal chip breaker, with good chip breakage at both low and high depths of cut ▲ Cutting edge finish available: sharp (F), rounded (E), chamfered (T) in line with ISO designation system 		Machining conditions		
				
		CTD4110	CTD4110	CTD4110

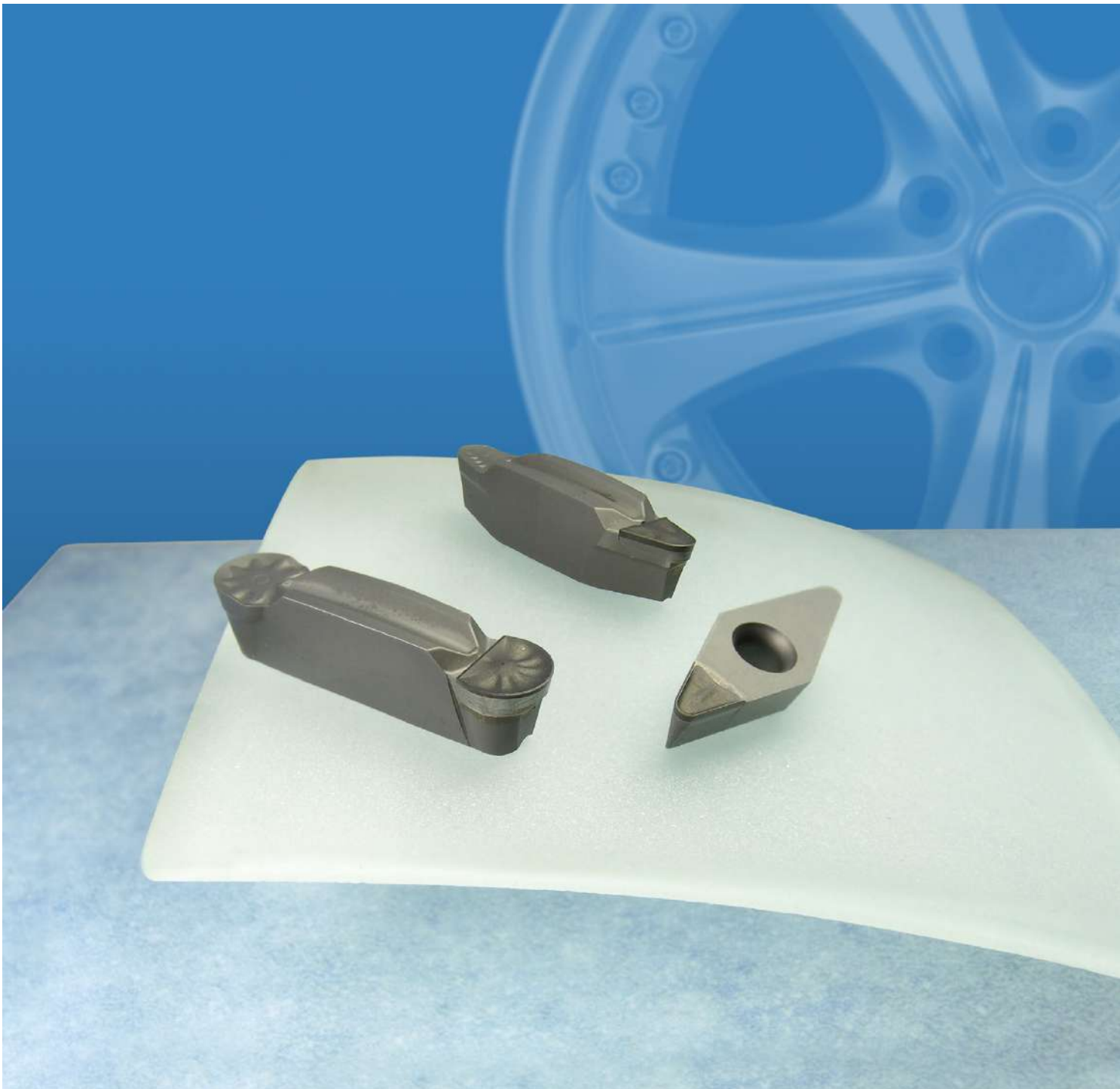

Designation system for indexable inserts

Indexable insert – metric



Indexable insert – inch

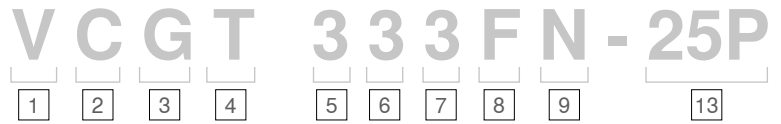

Indexable insert, PCD

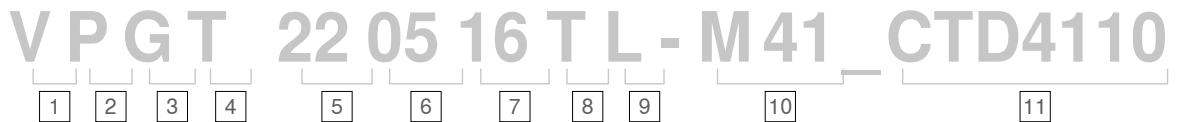

1

Insert shape

Rhombus	35°	V
	55°	D
	75°	E
	80°	C
	86°	M
Rhomboid	55°	K
	82°	B
	85°	A
Other shapes	90°	L
	108°	P
	120°	H
	135°	O
	-	R
	90°	S
	60°	T
80°	W	

2

Clearance angle

3°	A	25°	F
5°	B	30°	G
7°	C	0°	N
15°	D	11°	P
20°	E		

Clearance angle not included in the standard, for which particular information is required } O

3

Tolerances

	d ±		m ±		s ±	
	[mm]	[inch]	[mm]	[inch]	[mm]	[inch]
A	0,025	.0010	0,005	.0002	0,025	.001
F	0,013	.0005	0,005	.0002	0,025	.001
C	0,025	.0010	0,013	.0005	0,025	.001
H	0,013	.0005	0,013	.0005	0,025	.001
E	0,025	.0010	0,025	.0010	0,025	.001
G	0,025	.0010	0,025	.0010	0,13	.005
J	0,05-0,15*	.002-.006*	0,005	.0002	0,025	.001
K	0,05-0,15*	.002-.006*	0,013	.0005	0,025	.001
L	0,05-0,15*	.002-.006*	0,025	.0010	0,025	.001
M	0,05-0,15*	.002-.006*	0,05-0,20	.003-.008*	0,13	.005
N	0,05-0,15*	.002-.006*	0,05-0,20	.003-.008*	0,025	.001
U	0,08-0,25*	.003-.010*	0,13-0,38	.005-.015*	0,13	.005

* Dependent on the insert size

6

Insert thickness

		Index	
[inch]	[mm]	[mm]	[inch]
1/16	1,59	01	1
3/32	2,38	02	
1/8	3,18	03	2
5/32	3,97	T3	
3/16	4,76	04	3
7/32	5,56	05	
1/4	6,35	06	4
5/16	7,94	07	5
3/8	9,52	09	6

7

Corner radius

		Index		RN 00 RC MO
[mm]	[inch]	[mm]	[inch]	
≤ 0,05	.0015	00	X0	
0,1	.004	01	0	
0,2	.008	02	.5	
0,4	1/64	04	1	
0,8	1/32	08	2	
1,2	3/64	12	3	
1,6	1/16	16	4	
2,0	5/64	20	5	
2,4	3/32	24	6	
2,8	7/64	28	7	
3,2	1/8	32	8	

8

Cutting edge

F	Sharp
E	Rounded
T	Chamfered
S	Chamfered and rounded

4

Characteristic

N		
R		
F		
A		
M, P		
G, P		
W		
T		
Q		
U		
B		
H		
C		
J		
X	Special version	

[inch]

Changes at inscribed circle IK < 1/4"

IK > 1/4"	IK < 1/4"
N / R / F	E
A / M / G	D
X	X

5

Cutting length

Typ	ISO	ANSI	L		d	
			[mm]	[inch]	[mm]	[inch]
C	06	2	6,4	.250	6,35	.250
	09	3	9,7	.382	9,525	.375
	12	4	12,9	.508	12,70	.500
	16	5	16,1	.634	15,875	.625
	19	6	19,3	.760	19,05	.750
	25	8	25,8	1.016	25,4	1.000
S	06	2	6,35	.250	6,35	.250
	09	3	9,525	.375	9,525	.375
	12	4	12,7	.500	12,7	.500
	15	5	15,875	.625	15,875	.625
	19	6	19,05	.750	19,05	.750
	25	8	25,4	1.000	25,4	1.000
D	07	2	7,7	.303	6,35	.250
	11	3	11,6	.457	9,525	.375
	15	4	15,5	.610	12,70	.500
V	11	2	11,1	.437	6,35	.250
	16	3	16,6	.653	9,525	.375
	22	4	22,10	.870	12,70	.500

*) inch version

Typ	ISO	ANSI	L		d	
			[mm]	[inch]	[mm]	[inch]
T	06	1.2	6,9	.272	3,97	.156
	09	1.8	9,6	.378	5,56	.219
	11	2	11,0	.433	6,35	.250
	16	3	16,5	.650	9,525	.375
	22	4	22,0	.079	12,70	.039
	27	5	27,5	1.083	15,875	.625
W	33	6	33,0	1.299	19,05	.750
	06	3	6,5	.256	9,525	.375
	08	4	8,7	.331	12,70	.039
R	10	5	10,9	.429	15,875	.625
	06	2	6,35	.250	6,35	.250
	08	-	8,0	.315	8,0	.315
R	09	3	9,52	.375	9,52	.375
	10	-	10,0	.394	10,0	.394
	12	-	12,0	.472	12,0	.472
	12*	4	12,7	.488	12,70	.488
	15	5	15,875	.625	15,875	.625
	16	-	16,0	.630	16,0	.630
	19	6	19,05	.750	19,05	.750
	25	8	25,0	.984	25,0	.984
	25*	-	25,4	1.000	25,4	1.000
	31	10	31,75	1,250	31,75	1,250
32	-	32,0	1.260	32,0	1.260	

9

Direction of cut

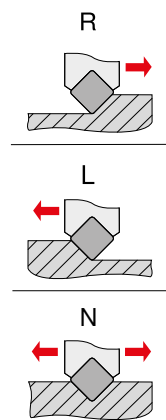

PCD segment position

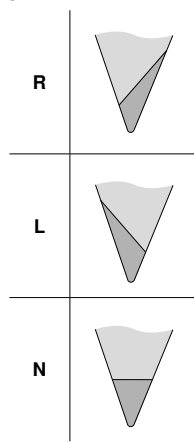

10

Chip breaker

- F4
- M4
- F41
- M41
- R41
- U41

For manufacturer's specifications, see Page 34

11

Grade

e.g.: CTP4110

13

Step designation

For manufacturer's specifications, see Page 34

Indexable insert system

DC..



P				
M				
K				
N	●	●	●	
S				
H				

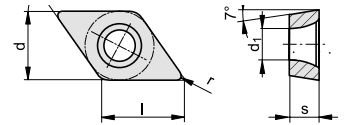

		H210T	H10T	H216T	l	d	s	d ₁
					[mm]	[mm]	[mm]	[mm]
0,20	DCGT 070202FN-25P	●			7,75	6,35	2,38	2,80
0,20	DCGT 070202FN-27		●		7,75	6,35	2,38	2,80
0,40	DCGT 070204FN-23P		●		7,75	6,35	2,38	2,80
0,40	DCGT 070204FN-25P	●			7,75	6,35	2,38	2,80
0,40	DCGT 070204FN-27		●		7,75	6,35	2,38	2,80
0,20	DCGT 11T302FN-25P	●			11,60	9,52	3,97	4,40
0,20	DCGT 11T302FN-27		●		11,60	9,52	3,97	4,40
0,40	DCGT 11T304FN-23P		●		11,60	9,52	3,97	4,40
0,40	DCGT 11T304FN-25P	●			11,60	9,52	3,97	4,40
0,40	DCGT 11T304FN-25Q	●			11,60	9,52	3,97	4,40
0,40	DCGT 11T304FL-25Q	●			11,60	9,52	3,97	4,40
0,40	DCGT 11T304FN-27		●		11,60	9,52	3,97	4,40
0,40	DCGT 11T304FR-25Q	●			11,60	9,52	3,97	4,40
0,80	DCGT 11T308FN-23P		●		11,60	9,52	3,97	4,40
0,80	DCGT 11T308FN-25P	●			11,60	9,52	3,97	4,40
0,80	DCGT 11T308FN-25Q	●			11,60	9,52	3,97	4,40
0,80	DCGT 11T308FL-25Q	●			11,60	9,52	3,97	4,40
0,80	DCGT 11T308FN-27		●		11,60	9,52	3,97	4,40
0,80	DCGT 11T308FR-25Q	●			11,60	9,52	3,97	4,40

- Main application
- Extended application

EcoCut



-27P



-27Q

P					
M					
K					
N	●				
S					
H					

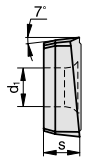
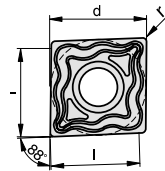

		H210T H216T	l [mm]	d [mm]	s [mm]	d ₁ [mm]	r [mm]
05	XCET 050202FN-27P	●	5,00	5,80	2,10	2,25	0,20
05	XCET 050202FN-27Q	●	5,00	5,80	2,10	2,25	0,20
05	XCET 050204FN-27P	●	5,00	5,80	2,10	2,25	0,40
05	XCET 050204FN-27Q	●	5,00	5,80	2,10	2,25	0,40
06	XCET 060202FN-27P	●	6,00	6,50	2,38	2,50	0,20
06	XCET 060202FN-27Q	●	6,00	6,50	2,38	2,50	0,20
06	XCET 060204FN-27P	●	6,00	6,50	2,38	2,50	0,40
06	XCET 060204FN-27Q	●	6,00	6,50	2,38	2,50	0,40
07	XCET 070304FN-27P	●	7,00	7,60	3,18	2,80	0,40
07	XCET 070304FN-27Q	●	7,00	7,60	3,18	2,80	0,40
08	XCET 080304FN-27P	●	8,00	8,50	3,18	3,40	0,40
08	XCET 080304FN-27Q	●	8,00	8,50	3,18	3,40	0,40
09	XCET 09T304FN-27P	●	9,00	9,60	3,97	3,40	0,40
09	XCET 09T304FN-27Q	●	9,00	9,60	3,97	3,40	0,40
10	XCET 10T304FN-27P	●	10,00	10,60	3,97	4,40	0,40
10	XCET 10T304FN-27Q	●	10,00	10,60	3,97	4,40	0,40
10	XCET 10T308FN-27P	●	10,00	10,60	3,97	4,40	0,80
10	XCET 10T308FN-27Q	●	10,00	10,60	3,97	4,40	0,80
13	XCET 130404FN-27P	●	12,50	13,50	4,76	5,30	0,40
13	XCET 130404FN-27Q	●	12,50	13,50	4,76	5,30	0,40
13	XCET 130408FN-27P	●	12,50	13,50	4,76	5,30	0,80
13	XCET 130408FN-27Q	●	12,50	13,50	4,76	5,30	0,80
17	XCET 170508FN-27P	●	16,00	17,50	5,56	5,30	0,80
17	XCET 170508FN-27Q	●	16,00	17,50	5,56	5,30	0,80

- Main application
- Extended application

GX16..



-27P

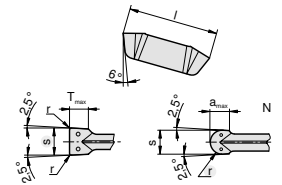
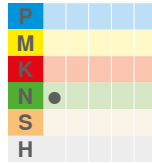

		H216T		l [mm]	a _{max} [mm]	r [mm]
2,00	GX16-1E2.00N0.20-27P	●		16,0	2,0	0,20
3,00	GX16-2E3.00N0.30-27P	●		16,0	2,5	0,30
3,00	GX16-2R1.50N-27P	●		16,0	1,5	1,50
4,00	GX16-3E4.00N0.40-27P	●		16,0	3,0	0,40
4,00	GX16-3R2.00N-27P	●		16,0	2,0	2,00
5,00	GX16-3R2.50N-27P	●		16,0	2,5	2,50
6,00	GX16-4E6.00N0.50-27P	●		16,0	3,5	0,50

GX24..



-25PF



-24PF



-27PF



-M4



-M41

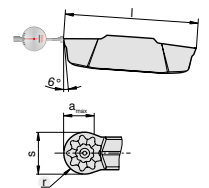
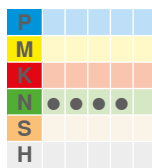

		H216T	CTD4110	H210T	AMZ	l [mm]	s [mm]	a _{max} [mm]
4,00	GX24-5R4.00EN-27DF		●			25,3	8,00	4,0
4,00	GX24-5R4.00FN-M41		●			25,3	8,00	4,0
4,00	GX24-5R4.00N-24PF	●				25,3	8,00	4,0
4,00	GX24-5R4.00N-25PF	●		●		25,3	8,00	4,0
4,00	GX24-5R4.00N-27PF	●		●		25,3	8,00	4,0
4,00	GX24-5R4.00N-M4		●			25,3	8,00	4,0
4,00	GX24-5R4.00TN-M4		●			25,3	8,00	4,0
4,00	GX24-5R4.00TN-M41		●			25,3	8,00	4,0

- Main application
- Extended application

HubStar

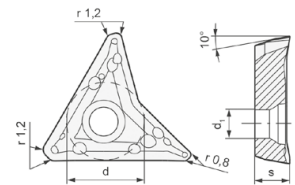
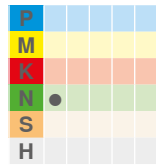

	H216T	s [mm]	d ₁ [mm]
HUB 120612N-24	●	6,35	5,50
HUB 150716L-27	●	7,00	5,80
HUB 1507QR-27	●	7,00	5,80

RC..

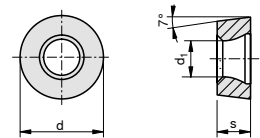
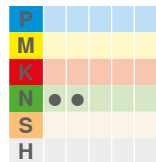

	H10T H210T	s [mm]	d ₁ [mm]
6,00 RCGT 0602MOFN-27	●	2,38	2,80
8,00 RCGT 0803MOFN-25P	●	3,18	3,40
8,00 RCMT 0803MOEN-25	●	3,18	3,40
8,00 RCGT 0803MOFN-27	●	3,18	3,40
10,00 RCGT 1003MOFN-27	●	3,18	4,00

- Main application
- Extended application

VC.. / VP..



-24P



-25P



-27

-28P

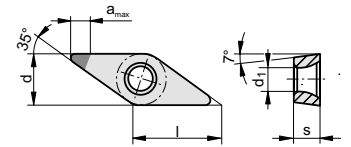
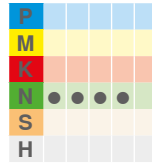

		AMZ	H2T6T	H10T	H2T0T	l	d	s
						[mm]	[mm]	[mm]
0,20	VCGT 110302FN-25P	●		●		11,10	6,35	3,18
0,20	VCGT 110302FN-27	●	●			11,10	6,35	3,18
0,40	VCGT 110304FN-25P	●		●		11,10	6,35	3,18
0,40	VCGT 110304FN-27	●	●			11,10	6,35	3,18
0,40	VCGT 160404FN-25P	●		●		16,60	9,52	4,76
0,40	VCGT 160404FN-27	●	●			16,60	9,52	4,76
0,80	VCGT 160408FN-24P			●		16,60	9,52	4,76
0,80	VCGT 110308FN-27		●			11,10	6,35	3,18
0,80	VCGT 160408FN-25P	●		●		16,60	9,52	4,76
0,80	VCGT 160408FN-27	●	●			16,60	9,52	4,76
1,20	VCGT 160412FN-24P			●		16,60	9,52	4,76
1,20	VCGT 160412FN-25P	●		●		16,60	9,52	4,76
1,20	VCGT 160412FN-27		●			16,60	9,52	4,76
1,20	VCGT 160412FN-28P		●			16,60	9,52	4,76
1,60	VPGT 220516FN-24P		●			22,10	12,70	5,56
1,60	VPGT 220516FN-25P			●		22,10	12,70	5,56
1,60	VPGT 220516FN-27		●			22,10	12,70	5,56
3,00	VCGT 220530FN-25P	●		●		22,10	12,70	5,56
3,00	VCGT 220530FN-27		●			22,10	12,70	5,56
3,00	VCMT 220530EN-25			●		22,10	12,70	5,56
3,00	VCGT 220530FN-24P		●			22,10	12,70	5,56

- Main application
- Extended application

VC.U.

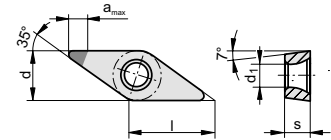
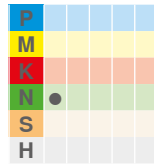
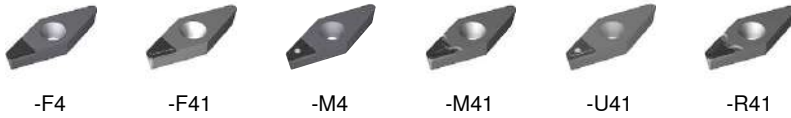

		CTD4110	l [mm]	d [mm]	s [mm]	a _{max} [mm]
0,80	VCUT 160408FN-M41	●	16,60	9,52	4,76	6,0
0,80	VCUW 160408TL-F4	●	16,60	9,52	4,76	13,5
0,80	VCUT 160408FN-F41	●	16,60	9,52	4,76	6,0
0,80	VCUT 160408FN-R41	●	16,60	9,52	4,76	6,0
0,80	VCUT 160408TL-R41	●	16,60	9,52	4,76	13,5
0,80	VCUT 160408FN-U41	●	16,60	9,52	4,76	6,0
0,80	VCUW 160408FN-M4	●	16,60	9,52	4,76	6,0
0,80	VCUW 160408TR-F4	●	16,60	9,52	4,76	13,5
0,80	VCUW 160408FR-F4	●	16,60	9,52	4,76	13,5
0,80	VCUT 160408SN-M41	●	16,60	9,52	4,76	6,0
0,80	VCUT 160408FR-M41	●	16,60	9,52	4,76	13,5
0,80	VCUW 160408FN-F4	●	16,60	9,52	4,76	6,0
0,80	VCUT 160408TL-M41	●	16,60	9,52	4,76	13,5
0,80	VCUT 160408FR-R41	●	16,60	9,52	4,76	13,5
0,80	VCUT 160408FL-F41	●	16,60	9,52	4,76	13,5
0,80	VCUT 160408TN-F41	●	16,60	9,52	4,76	6,0
0,80	VCUT 160408TN-U41	●	16,60	9,52	4,76	6,0
0,80	VCUT 160408FL-R41	●	16,60	9,52	4,76	13,5
0,80	VCUW 160408TN-F4	●	16,60	9,52	4,76	6,0
0,80	VCUT 160408FL-M41	●	16,60	9,52	4,76	13,5
0,80	VCUT 160408TL-F41	●	16,60	9,52	4,76	13,5
0,80	VCUT 160408TN-R41	●	16,60	9,52	4,76	6,0
0,80	VCUT 160408TN-M41	●	16,60	9,52	4,76	6,0
0,80	VCUT 160408SN-F41	●	16,60	9,52	4,76	6,0
0,80	VCUT 160408FR-F41	●	16,60	9,52	4,76	13,5
0,80	VCUT 160408TR-R41	●	16,60	9,52	4,76	13,5
0,80	VCUW 160408FL-F4	●	16,60	9,52	4,76	13,5
0,80	VCUT 160408TR-F41	●	16,60	9,52	4,76	13,5
0,80	VCUT 160408TR-M41	●	16,60	9,52	4,76	13,5
1,20	VCUT 160412TL-F41	●	16,60	9,52	4,76	13,5
1,20	VCUT 160412TL-M41	●	16,60	9,52	4,76	13,5
1,20	VCUT 160412TL-R41	●	16,60	9,52	4,76	13,5

- Main application
- Extended application



VC.U.

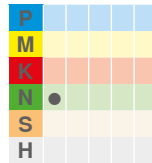

CTD4110

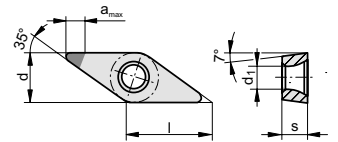

					l [mm]	d [mm]	s [mm]	a _{max} [mm]
1,20	VCUW 160412TN-F4	●			16,60	9,52	4,76	6,0
1,20	VCUT 160412FN-U41	●			16,60	9,52	4,76	6,0
1,20	VCUW 160412FL-F4	●			16,60	9,52	4,76	13,5
1,20	VCUT 160412SN-M41	●			16,60	9,52	4,76	6,0
1,20	VCUT 160412FR-M41	●			16,60	9,52	4,76	13,5
1,20	VCUW 160412TR-F4	●			16,60	9,52	4,76	13,5
1,20	VCUT 160412FR-R41	●			16,60	9,52	4,76	13,5
1,20	VCUT 160412TR-M41	●			16,60	9,52	4,76	13,5
1,20	VCUT 160412SN-F41	●			16,60	9,52	4,76	6,0
1,20	VCUW 160412FR-F4	●			16,60	9,52	4,76	13,5
1,20	VCUT 160412FR-F41	●			16,60	9,52	4,76	13,5
1,20	VCUT 160412TR-R41	●			16,60	9,52	4,76	13,5
1,20	VCUT 160412FN-F41	●			16,60	9,52	4,76	6,0
1,20	VCUW 160412SN-F4	●			16,60	9,52	4,76	6,0
1,20	VCUT 160412FN-R41	●			16,60	9,52	4,76	6,0
1,20	VCUT 160412FN-M41	●			16,60	9,52	4,76	6,0
1,20	VCUW 160412TN-M4	●			16,60	9,52	4,76	6,0
1,20	VCUW 160412FN-F4	●			16,60	9,52	4,76	6,0
1,20	VCUT 160412TN-U41	●			16,60	9,52	4,76	6,0
1,20	VCUT 160412TR-F41	●			16,60	9,52	4,76	13,5
1,20	VCUW 160412FN-M4	●			16,60	9,52	4,76	6,0
1,20	VCUT 160412TN-M41	●			16,60	9,52	4,76	6,0
1,20	VCUT 160412FL-M41	●			16,60	9,52	4,76	13,5
1,20	VCUT 160412FL-R41	●			16,60	9,52	4,76	13,5
1,20	VCUT 160412FL-F41	●			16,60	9,52	4,76	13,5
1,20	VCUW 160412TL-F4	●			16,60	9,52	4,76	13,5
1,20	VCUT 160412TN-F41	●			16,60	9,52	4,76	6,0
3,00	VCUT 220530EN-R41	●			22,10	12,70	5,56	6,0
3,00	VCUT 220530FL-F41	●			22,10	12,70	5,56	13,5
3,00	VCUT 220530FL-M41	●			22,10	12,70	5,56	13,5
3,00	VCUT 220530FL-R41	●			22,10	12,70	5,56	13,5
3,00	VCUT 220530FN-F41	●			22,10	12,70	5,56	6,0

● Main application
○ Extended application



VC.U.

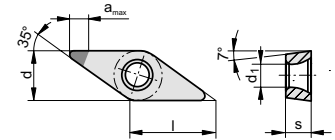
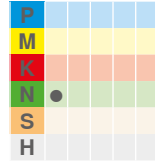
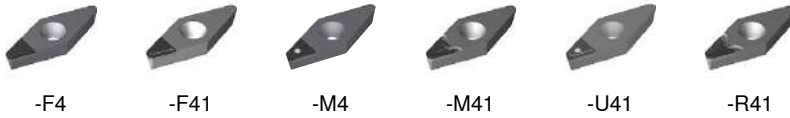

		CTD4110	l [mm]	d [mm]	s [mm]	a _{max} [mm]
3,00	VCUT 220530FN-M41	●	22,10	12,70	5,56	6,0
3,00	VCUT 220530FN-R41	●	22,10	12,70	5,56	6,0
3,00	VCUT 220530FN-U41	●	22,10	12,70	5,56	6,0
3,00	VCUT 220530FR-F41	●	22,10	12,70	5,56	13,5
3,00	VCUT 220530FR-M41	●	22,10	12,70	5,56	13,5
3,00	VCUT 220530FR-R41	●	22,10	12,70	5,56	13,5
3,00	VCUT 220530SR-R41	●	22,10	12,70	5,56	13,5
3,00	VCUT 220530TL-F41	●	22,10	12,70	5,56	13,5
3,00	VCUT 220530TL-M41	●	22,10	12,70	5,56	13,5
3,00	VCUT 220530TL-R41	●	22,10	12,70	5,56	13,5
3,00	VCUT 220530TN-F41	●	22,10	12,70	5,56	6,0
3,00	VCUT 220530TN-M41	●	22,10	12,70	5,56	6,0
3,00	VCUT 220530TN-R41	●	22,10	12,70	5,56	6,0
3,00	VCUT 220530TN-U41	●	22,10	12,70	5,56	6,0
3,00	VCUT 220530TR-F41	●	22,10	12,70	5,56	13,5
3,00	VCUT 220530TR-M41	●	22,10	12,70	5,56	13,5
3,00	VCUT 220530TR-R41	●	22,10	12,70	5,56	13,5
3,00	VCUW 220530FL-F4	●	22,10	12,70	5,56	13,5
3,00	VCUW 220530FN-F4	●	22,10	12,70	5,56	6,0
3,00	VCUW 220530FN-M4	●	22,10	12,70	5,56	6,0
3,00	VCUW 220530FR-F4	●	22,10	12,70	5,56	13,5
3,00	VCUW 220530TL-F4	●	22,10	12,70	5,56	13,5
3,00	VCUW 220530TN-F4	●	22,10	12,70	5,56	6,0
3,00	VCUW 220530TN-M4	●	22,10	12,70	5,56	6,0
3,00	VCUW 220530TR-F4	●	22,10	12,70	5,56	13,5
1,60	VPUT 220516FL-F41	●	22,10	12,70	5,56	13,5
1,60	VPUT 220516FL-M41	●	22,10	12,70	5,56	13,5
1,60	VPUT 220516FL-R41	●	22,10	12,70	5,56	13,5
1,60	VPUT 220516FN-M41	●	22,10	12,70	5,56	6,0
1,60	VPUT 220516FN-R41	●	22,10	12,70	5,56	6,0
1,60	VPUT 220516FN-F41	●	22,10	12,70	5,56	6,0
1,60	VPUT 220516TL-M41	●	22,10	12,70	5,56	13,5

- Main application
- Extended application



VC.U.

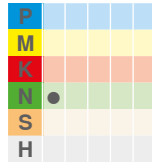

CTD4110

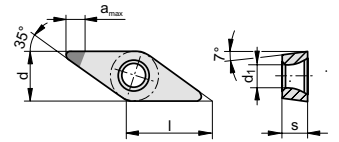

				l [mm]	d [mm]	s [mm]	a _{max} [mm]
1,60	VPUT 220516FR-F41	●		22,10	12,70	5,56	13,5
1,60	VPUT 220516FR-M41	●		22,10	12,70	5,56	13,5
1,60	VPUT 220516FR-R41	●		22,10	12,70	5,56	13,5
1,60	VPUT 220516TL-R41	●		22,10	12,70	5,56	13,5
1,60	VPUT 220516TN-F41	●		22,10	12,70	5,56	6,0
1,60	VPUT 220516TL-F41	●		22,10	12,70	5,56	13,5
1,60	VPUW 220516FR-F4	●		22,10	12,70	5,56	13,5
1,60	VPUT 220516TR-F41	●		22,10	12,70	5,56	13,5
1,60	VPUT 220516TN-M41	●		22,10	12,70	5,56	6,0
1,60	VPUT 220516TN-R41	●		22,10	12,70	5,56	6,0
1,60	VPUT 220516TR-M41	●		22,10	12,70	5,56	13,5
1,60	VPUT 220516TR-R41	●		22,10	12,70	5,56	13,5
1,60	VPUW 220516FL-F4	●		22,10	12,70	5,56	13,5
1,60	VPUW 220516TN-F4	●		22,10	12,70	5,56	6,0
1,60	VPUW 220516TL-F4	●		22,10	12,70	5,56	13,5
1,60	VPUW 220516FN-F4	●		22,10	12,70	5,56	6,0
1,60	VPUW 220516FN-M4	●		22,10	12,70	5,56	8,0
1,60	VPUW 220516TN-M4	●		22,10	12,70	5,56	8,0
1,60	VPUW 220516TR-F4	●		22,10	12,70	5,56	13,5
3,00	VPUT 220516TN-U41	●		22,10	12,70	5,56	6,0
3,00	VPUT 220516FN-U41	●		22,10	12,70	5,56	6,0

- Main application
- Extended application

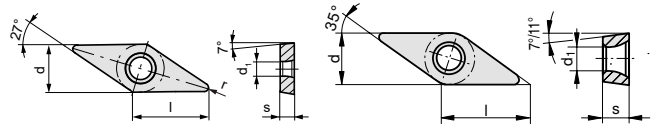
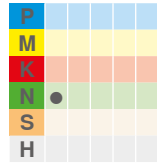
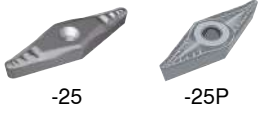
XC.. / VP..

		H216T	l [mm]	d [mm]	s [mm]	d ₁ [mm]
3,20	XCGT 400632FN-25	●	45,90	19,66	7,50	5,60
1,20	VPGX 220612FN-25P	●	22,10	12,90	6,35	5,16
1,20	VPGT 220612FN-25P	●	22,10	12,90	6,35	5,16

- Main application
- Extended application

X32..

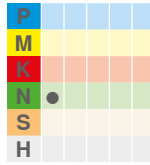

CTD4110

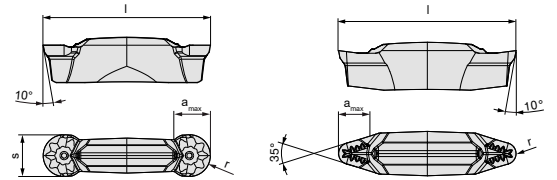

					l [mm]	s [mm]	a _{max} [mm]
1,60	X32-R1.60VFN-F4	●			32,0		3,0
1,60	X32-R1.60VFN-F41	●			32,0		3,0
1,60	X32-R1.60VFN-M4	●			32,0		3,0
1,60	X32-R1.60VFN-M41	●			32,0		3,0
1,60	X32-R1.60VFN-R41	●			32,0		3,0
1,60	X32-R1.60VTN-F4	●			32,0		3,0
1,60	X32-R1.60VTN-F41	●			32,0		3,0
1,60	X32-R1.60VTN-M4	●			32,0		3,0
1,60	X32-R1.60VTN-M41	●			32,0		3,0
1,60	X32-R1.60VTN-R41	●			32,0		3,0
1,60	X32-R1.60VTN-U41	●			32,0		3,0
2,00	X32-R2.00VFN-F41	●			32,0		3,0
2,00	X32-R2.00VFN-M4	●			32,0		3,0
2,00	X32-R2.00VFN-M41	●			32,0		3,0
2,00	X32-R2.00VFN-R41	●			32,0		3,0
2,00	X32-R2.00VFN-U41	●			32,0		3,0
2,00	X32-R2.00VTN-F4	●			32,0		3,0
2,00	X32-R2.00VTN-F41	●			32,0		3,0
2,00	X32-R2.00VTN-M4	●			32,0		3,0
2,00	X32-R2.00VTN-M41	●			32,0		3,0
2,00	X32-R2.00VTN-R41	●			32,0		3,0
2,00	X32-R2.00VTN-U41	●			32,0		3,0
3,00	X32-R3.00FN-F4	●			32,0	6,00	2,0
3,00	X32-R3.00FN-F41	●			32,0	6,00	2,0
3,00	X32-R3.00FN-M4	●			32,0	6,00	2,0
3,00	X32-R3.00FN-M41	●			32,0	6,00	2,0
3,00	X32-R3.00FN-R41	●			32,0	6,00	2,0
3,00	X32-R3.00FN-U41	●			32,0	6,00	2,0
3,00	X32-R3.00TN-F4	●			32,0	6,00	2,0
3,00	X32-R3.00TN-F41	●			32,0	6,00	2,0

- Main application
- Extended application



X32..



CTD4110

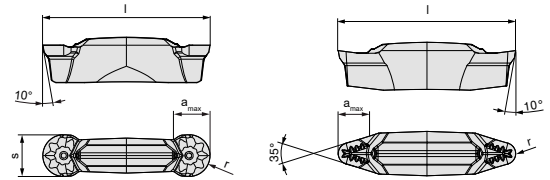

		CTD4110	l [mm]	s [mm]	a _{max} [mm]
3,00	X32-R3.00TN-M4	●	32,0	6,00	2,0
3,00	X32-R3.00TN-M41	●	32,0	6,00	2,0
3,00	X32-R3.00TN-R41	●	32,0	6,00	2,0
3,00	X32-R3.00TN-U41	●	32,0	6,00	2,0
4,00	X32-R4.00FN-F4	●	32,0	8,00	3,0
4,00	X32-R4.00FN-F41	●	32,0	8,00	3,0
4,00	X32-R4.00FN-M4	●	32,0	8,00	3,0
4,00	X32-R4.00FN-M41	●	32,0	8,00	3,0
4,00	X32-R4.00FN-R41	●	32,0	8,00	3,0
4,00	X32-R4.00FN-U41	●	32,0	8,00	3,0
4,00	X32-R4.00TN-F4	●	32,0	8,00	3,0
4,00	X32-R4.00TN-F41	●	32,0	8,00	3,0
4,00	X32-R4.00TN-M4	●	32,0	8,00	3,0
4,00	X32-R4.00TN-M41	●	32,0	8,00	3,0
4,00	X32-R4.00TN-R41	●	32,0	8,00	3,0
4,00	X32-R4.00TN-U41	●	32,0	8,00	3,0

- Main application
- Extended application

X32..

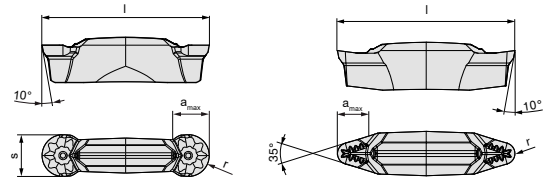
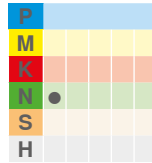

		H216T	l [mm]	s [mm]	a _{max} [mm]
1,60	X32-R1.60VN-23PF	●	32,0		5,0
1,60	X32-R1.60VN-27P	●	32,0		5,0
2,00	X32-R2.00VN-27P	●	32,0		5,0
3,00	X32-R3.00N-24PF	●	32,0	6,00	3,0
3,00	X32-R3.00N-27DPF	●	32,0	6,00	3,0
3,00	X32-R3.00N-27PF	●	32,0	6,00	3,0
4,00	X32-R4.00EN-27DPF	●	32,0	8,00	4,0
4,00	X32-R4.00N-24PF	●	32,0	8,00	4,0
4,00	X32-R4.00N-27PF	●	32,0	8,00	4,0
4,00	X32-R4.00N-35P	●	32,0	8,00	4,0

- Main application
- Extended application



Designation system for OvalFlex adapters

OC50 R - DIN69880 - 40 IN 175

1 2 3 4 5 6

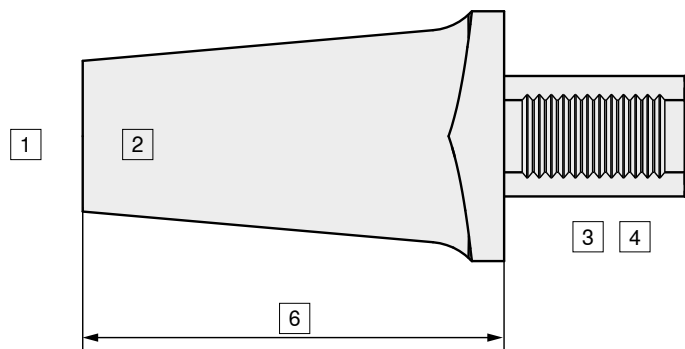

1

Interface on workpiece side

OC50

2

Assembly variant

...R Radial clamping

...L Axial clamping with power screws

3

Interface on machine side

- VDI (DIN 69880)
- OKUMA
- DOOSAN
- DANOBAT
- DUMA
- etc.

4

Diameter of interface on machine side

- 40 mm
- 50 mm
- etc.

5

Machining

-IN Internal machining

-ER External right

-IL Internal left

etc.

6

Length of adapter

e.g.: 175 mm

Designation system for OvalFlex heads

OC50 R S - X32 R 05 H

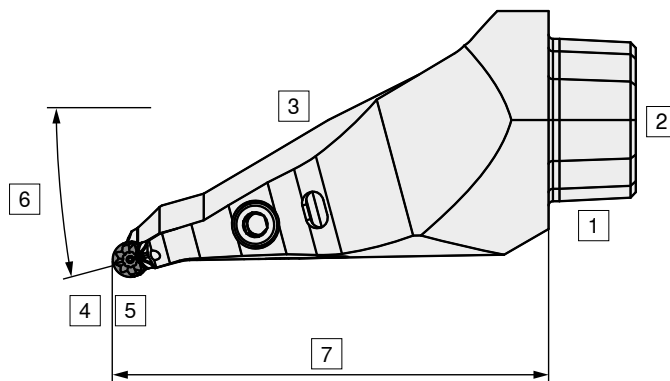

1

Interface on workpiece side

OC50

2

Assembly variant

...R Radial clamping

...L Axial clamping with power screws

3

Head variants

...S Strong (strengthened)

...L Normal

4

Indexable insert system

- X32
- V-indexable inserts
- etc.

5

Direction of cut

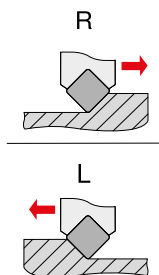

6

Angle of OvalFlex head

- 0°
- 5°
- 15°
- etc.

7

Tool length

See ISO

Base holders/Adapters

OvalFlex

External machining

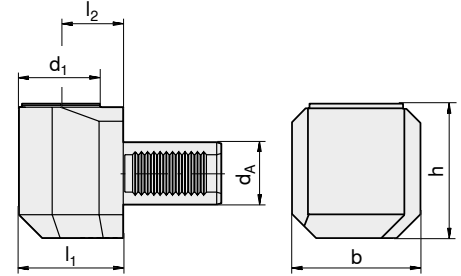

Type, designation	d_A [mm]	d_1 [mm]	l_1 [mm]	l_2 [mm]	b [mm]	h [mm]
OC50-DIN69880-40ER	40	50	67	40	86,5	83
OC50-DIN69880-50ER	50	50	77	50	104	98
OC50-DIN69880-40ER150	40	50	177	150	86,3	83
OC50-DIN69880-50ER150	50	50	177	150	104	98
OC50R-DIN69880-40ER	40	50	67	40	86,5	83
OC50R-DIN69880-50ER	50	50	77	50	104	98
OC50R-DIN69880-40ER150	40	50	177	150	86,5	83
OC50R-DIN69880-50ER150	50	50	177	150	104	98

d_A
[mm]



40	10002788/M16X1,5X6 SW8	10002105/M16X65 SW8	WS-L-SW8-200	7730102/GREASE	O-Ring 4,3-2,40	10011426/TORX25T/SW5/OVAL
50	10002788/M16X1,5X6 SW8	10002105/M16X65 SW8	WS-L-SW8-200	7730102/GREASE	O-Ring 4,3-2,40	10011426/TORX25T/SW5/OVAL

OvalFlex

Internal machining

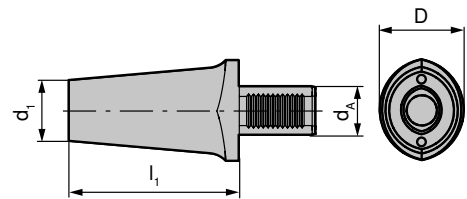

Type, designation	d_A [mm]	d_1 [mm]	l_1 [mm]	D [mm]
OC50-DIN69880-40IN110	40	50	110	83
OC50-DIN69880-40IN140	40	50	140	83
OC50-DIN69880-40IN175	40	50	175	83
OC50-DIN69880-50IN130	50	50	130	98
OC50-DIN69880-50IN170	50	50	170	98
OC50-DIN69880-50IN210	50	50	210	98
OC50R-DIN69880-40IN110	40	50	110	83
OC50R-DIN69880-40IN140	40	50	140	83
OC50R-DIN69880-50IN130	50	50	130	98
OC50R-DIN69880-50IN170	50	50	170	98

Spare part: for power screw clamping – to be used for clamping from the rear	d_A [mm]	Länge [mm]	
	40	240	OC50-KLINGE-SW8-240
	50	360	OC50-KLINGE-SW8-360

d_A [mm]						
40	10002788/M16X1,5X6 SW8	10002105/M16X65 SW8	WS-L-SW8-200	7730102/GREASE	O-Ring 4,3-2,40	10011426/TORX25T/SW5/OVAL
50	10002788/M16X1,5X6 SW8	10002105/M16X65 SW8	WS-L-SW8-200	7730102/GREASE	O-Ring 4,3-2,40	10011426/TORX25T/SW5/OVAL

OvalFlex

Internal machining

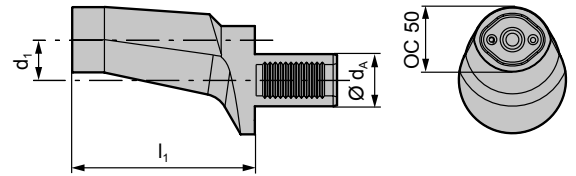
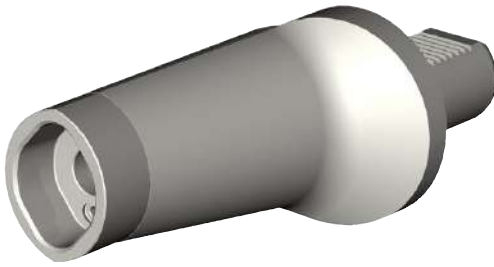

Type, designation	d_A [mm]	d_1 [mm]	l_1 [mm]
OC50-DIN69880-40IL140	40	50	140
OC50R-DIN69880-40IL140	40	50	140

Spare part: for power screw clamping – to be used for clamping from the rear	d_A [mm]	Länge [mm]	
	40	240	OC50-KLINGE-SW8-240
	50	360	OC50-KLINGE-SW8-360

d_A [mm]						
40	10002788/M16X1,5X6 SW8	10002105/M16X65 SW8	WS-L-SW8-200	7730102/GREASE	O-Ring 4,3-2,40	10011426/TORX25T/SW5/OVAL

OvalFlex – inch

Internal machining

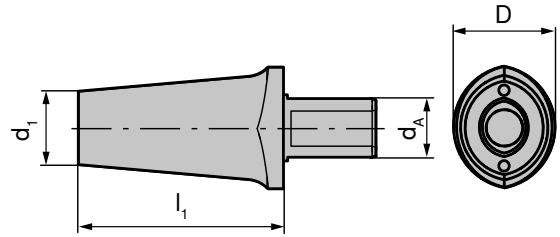

Type, designation	d_A [Inch]	d_1 [mm]	l_1 [inch]
OC50-2.5-5-E	2,500	50	5,000
OC50-2.5-8-E	2,500	50	8,000
OC50-2.5-10-E	2,500	50	10,000

Spare part:
for power screw
clamping – to be used for
clamping from the rear

d_A [mm]	Länge [mm]	
40	240	OC50-KLINGE-SW8-240
50	360	OC50-KLINGE-SW8-360

d_A [mm]					
40	10002788/M16X1,5X6 SW8	10002105/M16X65 SW8	WS-L-SW8-200mm	7730102/GREASE	O-Ring 4,3-2,40

Tool heads

OvalFlex



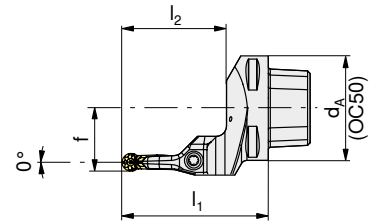
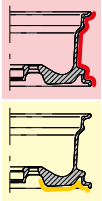

0°



Type, designation	L N R	d_A [mm]	l_1 [mm]	l_2 [mm]	f [mm]	
OC50-X32R00E	R	50	70	50	30	X32..
OC50-X32L00E	L	50	70	50	30	X32..
OC50R-X32R00E	R	50	70	50	30	X32..
OC50R-X32L00E	L	50	70	50	30	X32..



50-52

	d_A [mm]				
X32..	50	10001938/M5X20/T25	7883304/TORX T25 T	10002788/M16X1,5X6 SW8	
...R-X32..	50	10001938/M5X20/T25	7883304/TORX T25 T		11696356/OC50R-DEMOUNT SCREW

OvalFlex

0° – Strong

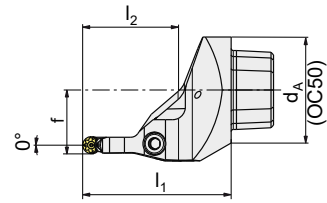
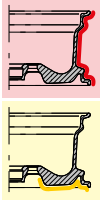

Type, designation	LNR 	d _A [mm]	l ₁ [mm]	l ₂ [mm]	f [mm]	
OC50S-X32R00E	R	50	70		30	X32.. R4..
OC50RS-X32R00E	R	50	70		30	X32.. R4..
OC50RS-X32L00E	L	50	70		30	X32.. R4..



51–52



d_A
[mm]





...S-X32.. R4..	50	M6X30 12.9 ISO 4762	10002788/M16X1,5X6 SW8
..RS-X32.. R4..	50	M6X30 12.9 ISO 4762	11696356/OC50R-DEMOUNT SCREW

OvalFlex

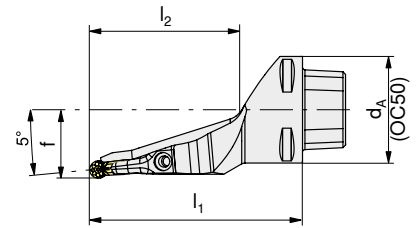



5°



Type, designation	LNR 	d_A [mm]	l_1 [mm]	l_2 [mm]	f [mm]	
OC50-X32R05H	R	50	100	66	32	X32..
OC50-X32L05H	L	50	100	66	32	X32..
OC50R-X32R05H	R	50	100	66	32	X32..
OC50R-X32L05H	L	50	100	66	32	X32..





50-52

	d_A [mm]				
X32..	50	10001938/M5X20/T25	7883304/TORX T25 T	10002788/M16X1,5X6 SW8	
...R-X32..	50	10001938/M5X20/T25	7883304/TORX T25 T		11696356/OC50R-DEMOUNT SCREW

OvalFlex

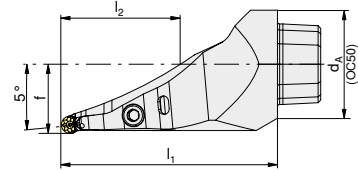
5° – Strong



Type, designation	LNR 	d_A [mm]	l_1 [mm]	l_2 [mm]	f [mm]	
OC50S-X32R05H	R	50	100	55	32	X32.. R4..



51-52



...S-X32.. R4..

d_A
[mm]
50



M6X30 12.9 ISO 4762



10002788/M16X1,5X6 SW8

OvalFlex



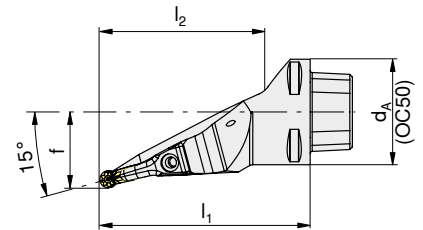
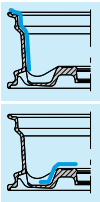

15°



Type, designation	L N R	d _A [mm]	l ₁ [mm]	l ₂ [mm]	f [mm]	
OC50-X32R15H	R	50	100	80	36	X32..
OC50-X32L15H	L	50	100	80	36	X32..
OC50R-X32R15H	R	50	100	80	36	X32..
OC50R-X32L15H	L	50	100	80	36	X32..





50-52

	d _A [mm]				
X32..	50	10001938/M5X20/T25	7883304/TORX T25 T	10002788/M16X1,5X6 SW8	
...R-X32..	50	10001938/M5X20/T25	7883304/TORX T25 T		11696356/OC50R-DEMOUNT SCREW

OvalFlex

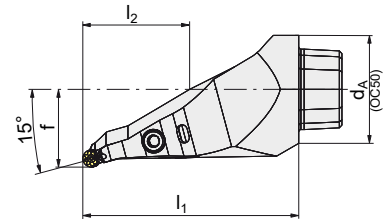
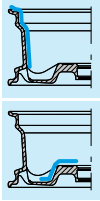
15° – Strong



Type, designation	LNR 	d_A [mm]	l_1 [mm]	l_2 [mm]	f [mm]	
OC50S-X32R15H	R	50	100		36	X32.. R4..
OC50RS-X32R15H	R	50	100		36	X32.. R4..
OC50RS-X32L15H	L	50	100		36	X32.. R4..



51–52



d_A
[mm]



...S-X32.. R4..	50	M6X30 12.9 ISO 4762	10002788/M16X1,5X6 SW8
..RS-X32.. R4..	50	M6X30 12.9 ISO 4762	11696356/OC50R-DEMOUNT SCREW

OvalFlex

22,5°

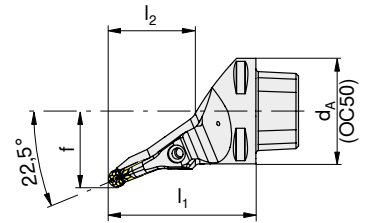
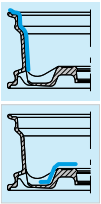

Type, designation	L N R 	d _A [mm]	l ₁ [mm]	l ₂ [mm]	f [mm]	
OC50-X32R22.5E	R	50	70	40	36	X32..
OC50-X32L22.5E	L	50	70	40	36	X32..
OC50R-X32R22.5E	R	50	70	40	36	X32..
OC50R-X32L22.5E	L	50	70	40	36	X32..



50-52



d_A
[mm]





X32..	50	10001938/M5X20/T25	7883304/TORX T25 T	10002788/M16X1,5X6 SW8	
...R-X32..	50	10001938/M5X20/T25	7883304/TORX T25 T		11696356/OC50R-DEMOUNT SCREW

OvalFlex

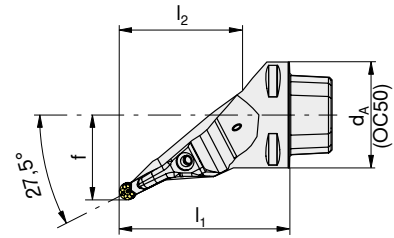
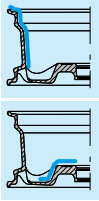



27,5°



Type, designation	LNR 	d_A [mm]	l_1 [mm]	l_2 [mm]	f [mm]	
OC50-X32R27.5F	R	50	80	60	40	X32..
OC50-X32L27.5F	L	50	80	60	40	X32..
OC50R-X32R27.5E	R	50	70	50	40	X32..
OC50R-X32L27.5E	L	50	70	50	40	X32..





50-52

	d_A [mm]				
X32..	50	10001938/M5X20/T25	7883304/TORX T25 T	10002788/M16X1,5X6 SW8	
...R-X32..	50	10001938/M5X20/T25	7883304/TORX T25 T		11696356/OC50R-DEMOUNT SCREW

OvalFlex

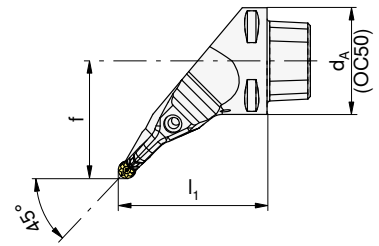
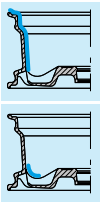



45°



Type, designation	L N R	d _A [mm]	l ₁ [mm]	f [mm]	
OC50-X32R45E	R	50	70	55	X32..
OC50-X32L45E	L	50	70	55	X32..
OC50R-X32R45E	R	50	70	55	X32..
OC50R-X32L45E	L	50	70	55	X32..





50-52

	d _A [mm]				
X32..	50	10001938/M5X20/T25	7883304/TORX T25 T	10002788/M16X1,5X6 SW8	
...R-X32..	50	10001938/M5X20/T25	7883304/TORX T25 T		11696356/OC50R-DEMOUNT SCREW

OvalFlex

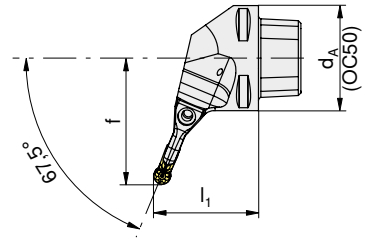



67,5°



Type, designation	LNR 	d _A [mm]	l ₁ [mm]	f [mm]	
OC50-X32R67.5C	R	50	50	60	X32..
OC50-X32R67.5E	R	50	70	60	X32..
OC50-X32L67.5C	L	50	50	60	X32..
OC50-X32L67.5E	L	50	70	60	X32..
OC50R-X32R67.5E	R	50	70	60	X32..
OC50R-X32L67.5E	L	50	70	60	X32..





50-52

	d _A [mm]				
X32..	50	10001938/M5X20/T25	7883304/TORX T25 T	10002788/M16X1,5X6 SW8	
...R-X32..	50	10001938/M5X20/T25	7883304/TORX T25 T		11696356/OC50R-DEMOUNT SCREW

OvalFlex

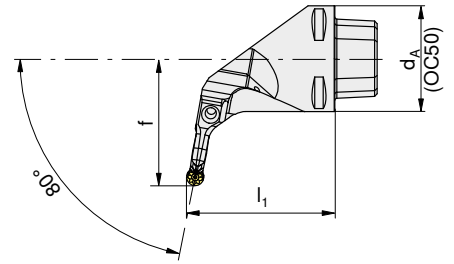



80°



Type, designation	L N R	d _A [mm]	l ₁ [mm]	f [mm]	
OC50-X32R80E	R	50	70	60	X32..
OC50-X32L80E	L	50	70	60	X32..
OC50R-X32R80E	R	50	70	60	X32..
OC50R-X32L80E	L	50	70	60	X32..



50-52

	d _A [mm]				
X32..	50	10001938/M5X20/T25	7883304/TORX T25 T	10002788/M16X1,5X6 SW8	
...R-X32..	50	10001938/M5X20/T25	7883304/TORX T25 T		11696356/OC50R-DEMOUNT SCREW

Hub tools

OvalFlex



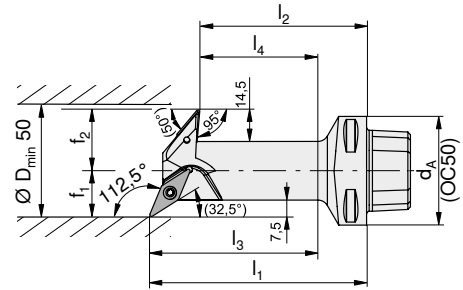
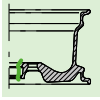

112,5°



Type, designation	LNR	d _A [mm]	l ₁ [mm]	l ₂ [mm]	l ₃ [mm]	l ₄ [mm]	f [mm]	f ₁ [mm]	
OC50-D50R112.5H	R	50	100	77	82,0	59,0	21	28,0	VC.. 160408..
OC50R-D50R112.5H	R	50	100	77	82,0	59,0	21	28,0	VC.. 160408..





44-46

	d _A [mm]			
VC.. 160408..	50	7815102/M3,5X11,0/T15	7883301/KOMBI T15	
...R ...VC.. 160408..	50	7815102/M3,5X11,0/T15	7883301/KOMBI T15	11696356/OC50R-DEMOUNT SCREW

HubStar

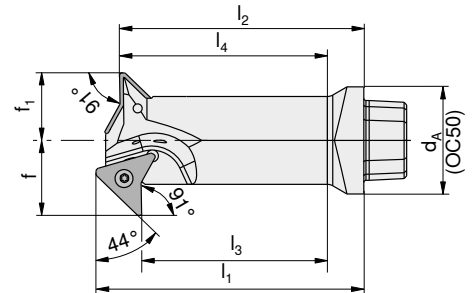
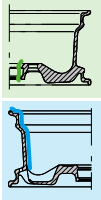
OvalFlex



Type, designation	LNR 	d _A [mm]	l ₁ [mm]	l ₂ [mm]	l ₃ [mm]	l ₄ [mm]	f [mm]	f ₁ [mm]	
OC50-HUB56R15K	R	50	125	112	82,7	91,0	28	26,5	HUB 1507...
OC50-HUB60R15K	R	50	125	112	82,7	91,0	30	27,5	HUB 1507...
OC50-HUB65R15K	R	50	125	112	86,7	95,0	32,5	30,0	HUB 1507...
OC50R-HUB48R12K	R	50	125	112	82,7	91,0	24	22,5	HUB 1206...
OC50R-HUB56R15K	R	50	125	112	82,7	91,0	28	26,5	HUB 1507...
OC50R-HUB60R15K	R	50	125	112	82,7	91,0	30	27,5	HUB 1507...
OC50R-HUB65R15K	R	50	125	112	86,7	95,0	32,5	30,0	HUB 1507...



43

d_A
[mm]

HUB 1206...	50	7883202/M4,5X12/T15	7897208/TORX T15 T	
...R...HUB 1206...	50	7883202/M4,5X12/T15	7897208/TORX T15 T	11696356/OC50R-DEMOUNT SCREW
HUB 1507...	50	M5,0X10,8-20IP/10022539	7897207/TORX T20 T	
...R...HUB 1507...	50	M5,0X10,8-20IP/10022539	7897207/TORX T20 T	11696356/OC50R-DEMOUNT SCREW



Designation system for tool holders

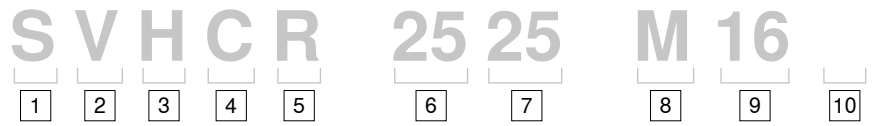





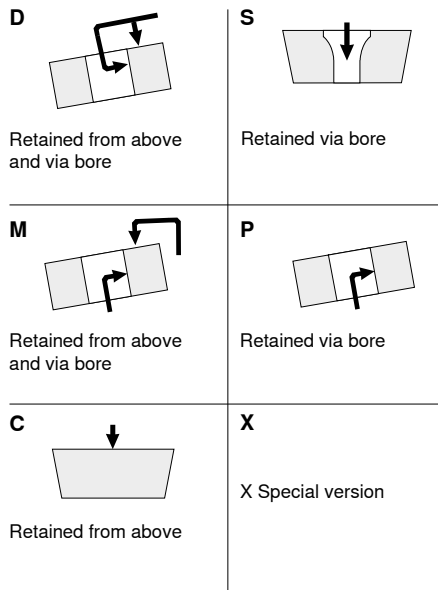





1

Tool holder



2

Insert shape

Corner angle Rhombus		35°	V			
		55°	D			
		75°	E			
		80°	C			
		86°	M			
Corner angle Rhomboid		55°	K			
		82°	B			
		85°	A			
Other shapes	90°	L		-		R
	108°	P		90°		S
	120°	H		60°		T
	135°	O		80°		W

6

Shank height



7

Shank width

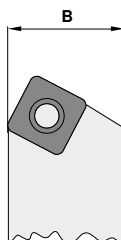

8

Tool length

l_1 mm	l_1 inch		l_1 mm	l_1 inch	
32	4.000	A	160	4.500	N
40	4.500	B	170	5.500	P
50	5.000	C	180	-	Q
60	6.000	D	200	6.000	R
70	7.000	E	250	7.000	S
80	8.000	F	300	8.000	T
90	5.500	G	350	5.500	U
100	5.625	H	400	3.500	V
110	5.300	J	450	3.500	W
125	14.000	K	500	3.750	Y
140	6.800	L	Special version		X
150	4.400	M			

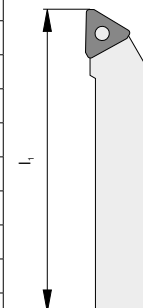

3

Holder shape

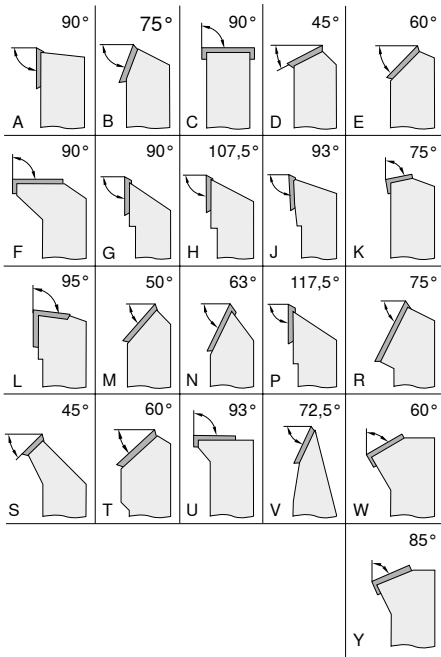

4

Clearance angle

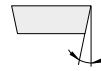

3°	A	25°	F
5°	B	30°	G
7°	C	0°	N
15°	D	11°	P
20°	E	*)	O

*) Clearance angle not included in the standard, for which particular information is required

5

Direction of cut

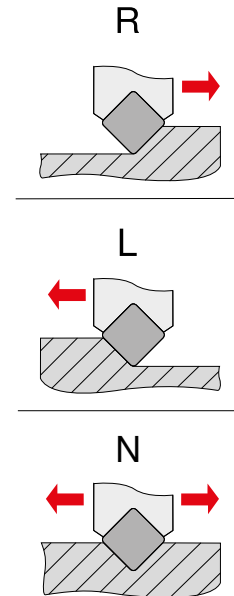

9

Cutting length

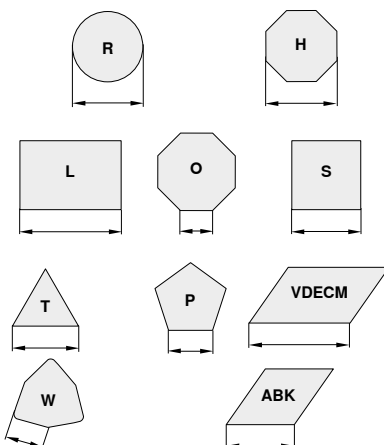

10

Manufacturer specification

Insert size

Designation system for boring bars



1

Shank type

S Steel shank	E As C with coolant hole
A Steel shank with coolant hole	F As C with antivibration system
B Steel shank with antivibration system	G As C with coolant hole and antivibration system
D Steel shank with coolant hole and antivibration system	H Heavy metal
C Carbide shank with steel head	J Heavy metal with coolant hole

5

Insert shape

Corner angle Rhombus			35°	V	
			55°	D	
			75°	E	
			80°	C	
Corner angle Rhomboid			86°	M	
			55°	K	
			82°	B	
		85°	A		
90°	L		-		R
108°	P		90°		S
120°	H		60°		T
135°	O		80°		W

6

Holder shape

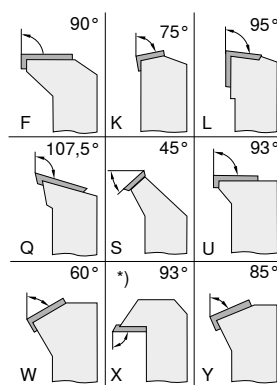

*) CERATIZIT factory standard

7

Clearance angle

3°	A	25°	F
5°	B	30°	G
7°	C	0°	N
15°	D	11°	P
20°	E	*	O

*) Clearance angle not included in the standard, for which particular information is required

2

Shank diameter

d ₁ mm	d ₁ inch
08	A two-digit figure indicating the boring bar diameter in 1/16 of an inch.
10	
12	
16	
20	
25	
32	
40	
50	
60	

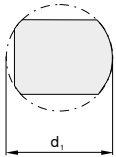

3

Tool length

l ₁ mm	l ₁ inch	
80	3	F
100	3,5	H
110	4	J
125	4,5	K
140	5	L
150	5,5	M
160	6	N
170	6,5	P
180	6,75	Q
200	7	R
250	8	S
300	10	T
350	12	U
400	14	V
450	16	W
500	18	Y
Special version		X

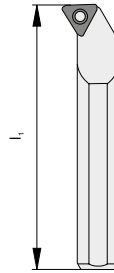

4

Clamping

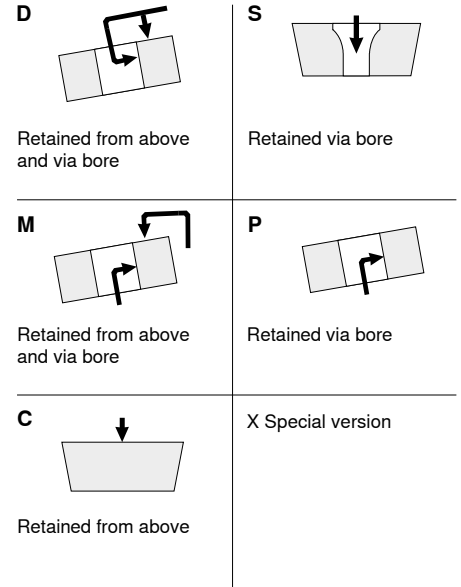

8

Direction of cut

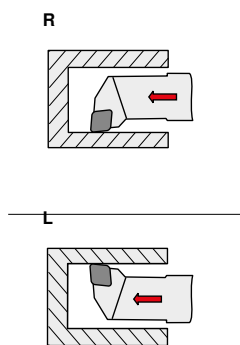

9

Cutting length

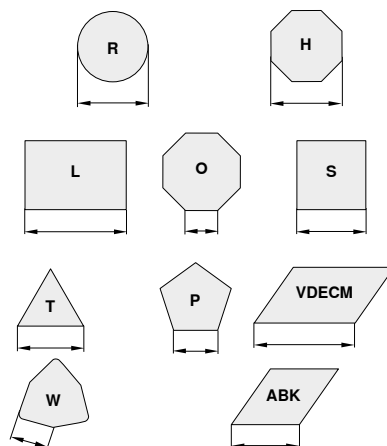

10

Manufacturer specification



Insert size

Shank tools

X32

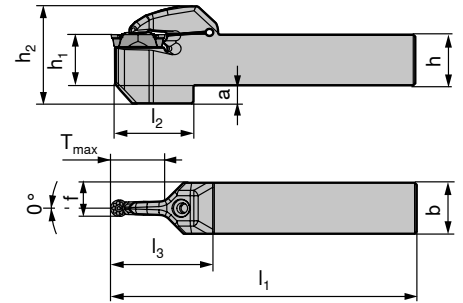
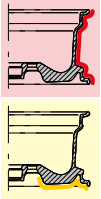
0° neutral



h [mm]	Type, designation	LNR 	h ₁ [mm]	h ₂ [mm]	b [mm]	f [mm]	l ₁ [mm]	l ₂ [mm]	l ₃ [mm]	a [mm]	T _{max} [mm]	
25	X32N00-2525M	N	25	39,0	25	16,5	150	24	40,0	9	24	X32..
32	X32N00-3225P	N	32	46,0	25	16,5	170	24	40,0	4	24	X32..



50-52



X32..

h
[mm]

25-32



10001938/M5X20/T25



7883304/TORX T25 T

X32

0°

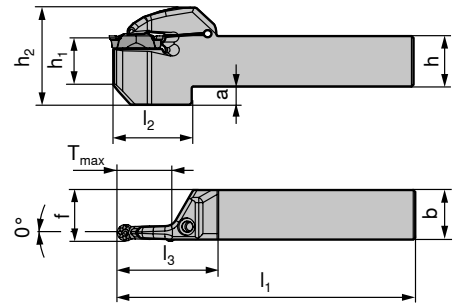
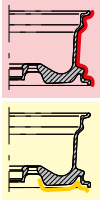

h	Type, designation	LNR	h ₁ [mm]	h ₂ [mm]	b [mm]	f [mm]	l ₁ [mm]	l ₂ [mm]	l ₃ [mm]	a [mm]	
25	X32R00-2525M	R	25	39,0	25	25,5	150	24	40,0	9	24
32	X32R00-3225P	R	32	46,0	25	25,5	170	24	40,0	4	24
25	X32L00-2525M	L	25	39,0	25	25,5	150	24	40,0	9	24
32	X32L00-3225P	L	32	46,0	25	25,5	170	24	40,0	4	24



50-52



X32..

h
[mm]

25-32



10001938/M5X20/T25





7883304/TORX T25 T

X32

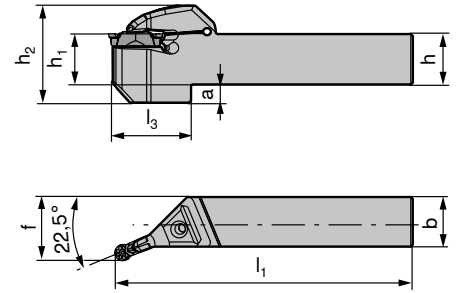
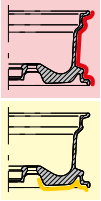
22,5°



h [mm]	Type, designation	LNR 	h ₁ [mm]	h ₂ [mm]	b [mm]	f [mm]	l ₁ [mm]	l ₃ [mm]	a [mm]	
25	X32R22.5-2525M	R	25	39,0	25	32	150	40,0	9	X32..
32	X32R22.5-3225P	R	32	46,0	25	32	170	40,0	4	X32..
25	X32L22.5-2525M	L	25	39,0	25	32	150	40,0	9	X32..
32	X32L22.5-3225P	L	32	46,0	25	32	170	40,0	4	X32..



50-52



X32..

h
[mm]

25-32



10001938/M5X20/T25





7883304/TORX T25 T

MaxiLock S

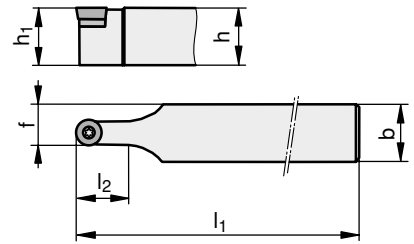
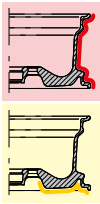
SRDC...



h_1 [mm]	Type, designation	LN R 	h [mm]	b [mm]	l_1 [mm]	l_2 [mm]	f [mm]	
25	SRDCN 2525 M06	N	25	25	150	12,4	15,5	RC.. 0602..
25	SRDCN 2525 M08	N	25	25	150	16,5	16,5	RC.. 0803..
25	SRDCN 2525 M10	N	25	25	150	20,9	17,5	RC.. 1003..



43



h
[mm]



1



2



3



4



5

Set 1-4

RC.. 0602..	12-25	7815101/M2,5X6,0/T08	SD-T08-60mm				7815902/SORT
RC.. 0803..	16-25	7883203/M3,0X7,3/T08	SD-T08-60mm				7883907/SORT
RC.. 1003..	16-25	7815102/M3,5X11,0/T15		7883301/KOMBI T15	7817002/HM-U	7883102/B M 3,5	7817902/SORT

MaxiLock S

SRGC...

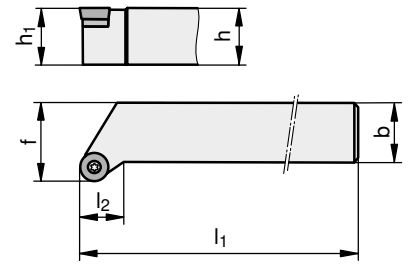
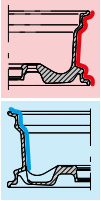

h [mm]	Type, designation	LNR 	h ₁ [mm]	l ₁ [mm]	l ₂ [mm]	f [mm]	
25	SRGCR 2525 M06	R	25	150	18,5	32	RC.. 0602..
25	SRGCR 2525 M08	R	25	150	19,6	32	RC.. 0803..
25	SRGCR 2525 M10	R	25	150	19,6	32	RC.. 1003..
25	SRGCL 2525 M06	L	25	150	18,5	32	RC.. 0602..
25	SRGCL 2525 M08	L	25	150	19,6	32	RC.. 0803..
25	SRGCL 2525 M10	L	25	150	19,6	32	RC.. 1003..



43



h
[mm]



1



2



3



4



5

Set 1-4

RC.. 0602..	12 - 25	7815101/M2,5X6,0/T08	SD-T08-60mm				7815902/SORT
RC.. 0803..	16 - 25	7883203/M3,0X7,3/T08	SD-T08-60mm				7883907/SORT
RC.. 1003..	16 - 25	7815102/M3,5X11,0/T15		7883301/KOMBI T15	7817002/HM-U	7883102/B M 3,5	7817902/SORT

MaxiLock S

SVHC...

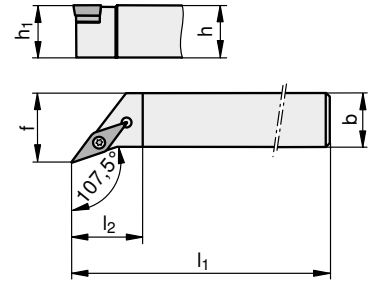
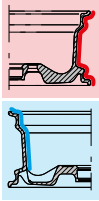

h [mm]	Type, designation	LN R	h_1 [mm]	l_1 [mm]	l_2 [mm]	f [mm]	
25	SVHCR 2525 M16	R	25	150	20,0	32	VC.. 1604..
25	SVHCR 2525 M22	R	25	150	21,9	32	VC.. 2205..
32	SVHCR 3225 P16	R	32	170	20,0	32	VC.. 1604..
32	SVHCR 3225 P22	R	32	170	21,9	32	VC.. 2205..
25	SVHCL 2525 M16	L	25	150	20,0	32	VC.. 1604..
25	SVHCL 2525 M22	L	25	150	21,9	32	VC.. 2205..
32	SVHCL 3225 P16	L	32	170	20,0	32	VC.. 1604..
32	SVHCL 3225 P22	L	32	170	21,9	32	VC.. 2205..



44-47



	h [mm]	1	2	3	4	5	Set 1-4
VC.. 1103..	12-20	7815101/M2,5X6,0/T08	SD-T08-60mm				7815902/SORT
VC.. 1604..	20-25	7815102/M3,5X11,0/T15		7815002/HM-U	7883301/KOMBI T15	7883102/B M 3,5	7815901/SORT
VC.. 2205..	12-32	7883202/M4,5X12/T15		7815004/HM-U	7883301/KOMBI T15	7883101/B M 4,5	7883911/SORT

MaxiLock S

SVZC/SVZP...

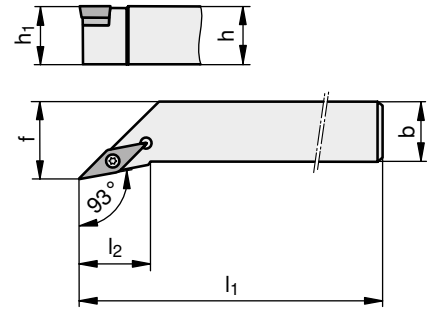
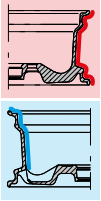

h [mm]	Type, designation	LNR 	h ₁ [mm]	l ₁ [mm]	l ₂ [mm]	f [mm]	
25	SVZCR 2525 M16	R	25	150	27,3	32	VC.. 1604..
25	SVZPR 2525 M22-16	R	25	150	32,3	32	VP.. 2205..
25	SVZCL 2525 M16	L	25	150	27,3	32	VC.. 1604..
25	SVZPL 2525 M22-16	L	25	150	32,3	32	VP.. 2205..



44-47



h
[mm]



1



2



3



4

Set 1-4

VC.. 1604..	25	7815102/M3,5X11,0/T15	7883301/KOMBI T15	7815002/HM-U	7883102/B M 3,5	7815901/SORT
VP.. 2205..	25	7883202/M4,5X12/T15	7883301/KOMBI T15	7815005/HM-U	7883101/B M 4,5	7883912/SORT

Boring bars

MaxiLock S

SVUC...

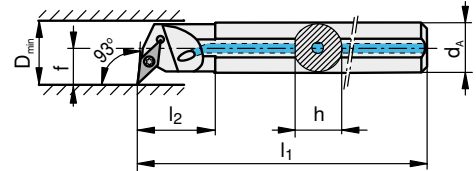
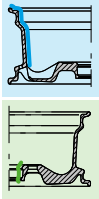

d_A [mm]	Type, designation	LNR 	h [mm]	l_1 [mm]	l_2 [mm]	f [mm]	
32	A32S SVUCR 16	R	30	250	50	22	VC.. 1604..
40	A40T SVUCR 16	R	38	300	60	27	VC.. 1604..
32	A32S SVUCL 16	L	30	250	50	22	VC.. 1604..
40	A40T SVUCL 16	L	38	300	60	27	VC.. 1604..



44-46



d_A
[mm]

1

2

3

4

Set 1-4

VC.. 1604..

32-40

7815102/M3,5X11,0/T15

7883301/KOMBI T15

7883102/B M 3,5

7815002/HM-U

7815901/SORT

MaxiLock S

SVQC...

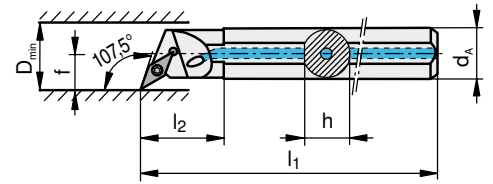
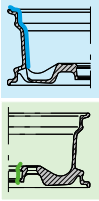

d_A [mm]	Type, designation	LNR 	h [mm]	l_1 [mm]	l_2 [mm]	f [mm]	
32	A32S SVQCR 16	R	30	250	50	22	VC.. 1604..
40	A40T SVQCR 16	R	38	300	60	27	VC.. 1604..
32	A32S SVQCL 16	L	30	250	50	22	VC.. 1604..
40	A40T SVQCL 16	L	38	300	60	27	VC.. 1604..



44-46



d_A
[mm]



1



2



3



4

Set 1-4

VC.. 1604..

32-40

7815102/M3,5X11,0/T15

7883301/KOMBI T15

7883102/B M 3,5



7815002/HM-U

7815901/SORT

MaxiLock S

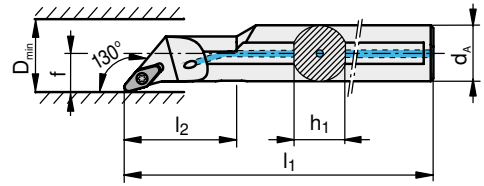
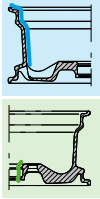
SVXC/P



d_A [mm]	Type, designation	LNR 	h [mm]	l_1 [mm]	l_2 [mm]	f [mm]	D_{min} [mm]	
40	A40S SVXCR 22	R	37	250	80	27	45	VC.. 2205..
40	A40S SVXPR 22-16	R	37	250	80	27	45	VP.. 2205..
40	A40S SVXCL 22	L	37	250	80	27	45	VC.. 2205..
40	A40S SVXPL 22-16	L	37	250	80	27	45	VP.. 2205..



46-47



d_A
[mm]





VC.. 2205..	40	7883202/M4,5X12/T15	7724103/TORX T15	7896900/O-RING 40
VP.. 2205..	40	7883202/M4,5X12/T15	7724103/TORX T15	7896900/O-RING 40

Shank tools

MSS-Mono

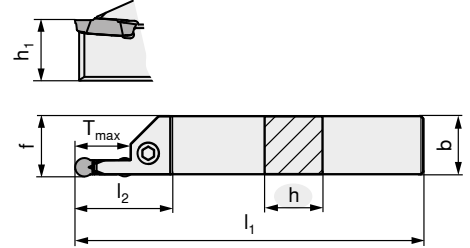
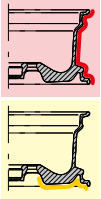



MSS-Mono



h [mm]	Type, designation	LNR 	h ₁ [mm]	b [mm]	l ₁ [mm]	l ₂ [mm]	f [mm]	T _{max} [mm]	
25	E25R00-2525M-GX24-4	R	25	25	150	42	25,9	24	GX24-4..
25	E25R00-2525M-GX24-5	R	25	25	150	42	25,9	24	GX24-5..
32	E32R00-3232P-GX24-5	R	32	32	170	42	33	24	GX24-5..
25	E25L00-2525M-GX24-4	L	25	25	150	42	25,9	24	GX24-4..
25	E25L00-2525M-GX24-5	L	25	25	150	42	25,9	24	GX24-5..
32	E32L00-3232P-GX24-5	L	32	32	170	42	33	24	GX24-5..



42

	h [mm]			
GX24-4..	25	7812115/M6X20 DIN 912	7812301/SW 5	
GX24-5..	25	7812115/M6X20 DIN 912	7812301/SW 5	
GX24-5..	32	7812115/M6X20 DIN 912	7812301/SW 5	7802180/A 2,2

Boring bars

MSS-Mono

5°

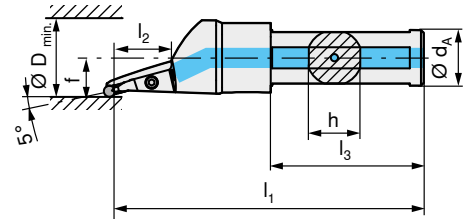
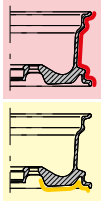

d_A [mm]	Type, designation	LNR 	h [mm]	l_1 [mm]	l_2 [mm]	f [mm]	
40	I40R05-1.0D-GX24-4	R	37	230	40	28	GX24-4..
40	I40L05-1.0D-GX24-4	L	37	230	40	28	GX24-4..
40	I40R05-2.00D-GX24-5	R	37	230	80	28	GX24-5..
40	I40L05-2.00D-GX24-5	L	37	230	80	28	GX24-5..



42

	h [mm]					
GX24-4..	37	7879060/M6X16 DIN912- 12.9	7896904/SD 8X6		7802180/A 2,2	7896900/O-RING 40
GX24-5..	37	7879060/M6X16 DIN912- 12.9	7896904/SD 8X6	7812301/SW 5	7802180/A 2,2	7896900/O-RING 40

MSS-Mono

15°

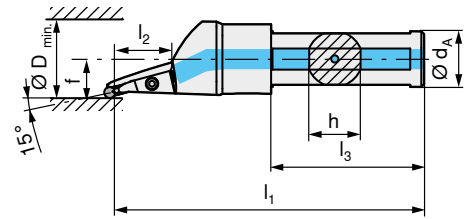
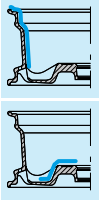

d_A [mm]	Type, designation	LNR 	h [mm]	l_1 [mm]	l_2 [mm]	f [mm]	
40	I40R15-1.38D-GX24-5	R	37	230	55	28	GX24-5..
40	I40R15-2.00D-GX24-5	R	37	230	80	28	GX24-5..
40	I40L15-1.38D-GX24-5	L	37	230	55	28	GX24-5..
40	I40L15-2.00D-GX24-5	L	37	230	80	28	GX24-5..



42



GX24-5..

h
[mm]

37



7879060/M6X16 DIN912- 12.9



7896904/SD 8X6



7812301/SW 5



7802180/A 2,2





7896900/O-RING 40

MSS-Mono

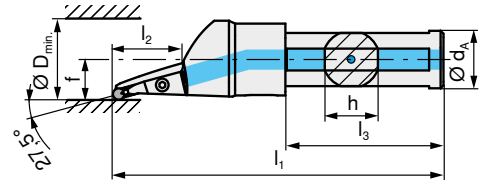
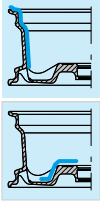
27°



d_A [mm]	Type, designation	LNR 	h [mm]	l_1 [mm]	l_2 [mm]	f [mm]	
40	I40R27.5-1.38D-GX24-5	R	37	230	55	28	GX24-5..





42

	h [mm]					
GX24-5..	37	7879060/M6X16 DIN912- 12.9	7896904/SD 8X6	7812301/SW 5	7802180/A 2,2	7896900/O-RING 40

Drilling

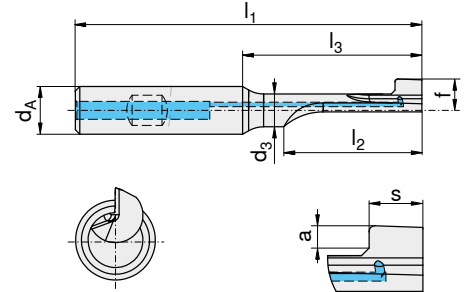
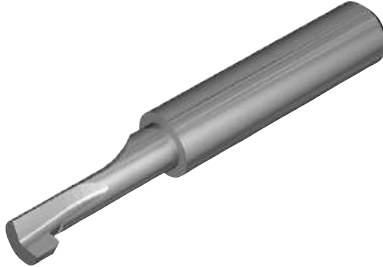
Reverse countersink tool



d_A [mm]	Type, designation	LNR 	l_1 [mm]	l_2 [mm]	l_3 [mm]	d_3 [mm]	f [mm]	s [mm]	a [mm]
16	S.AL.C.2060.R.01.IK	R	116	40	60	11	10,3	9	4,05
16	S.AL.C.2100.R.01.IK	R	116	33	60	11	10,5	9	3,75
16	S.AL.P.2000.R.01.IK	R	106	25	48	11	10,0	6	3,85
16	S.AL.P.2110.R.01.IK	R	106	25	48	11	10,6	6	4,35

Reverse countersink tool PCD

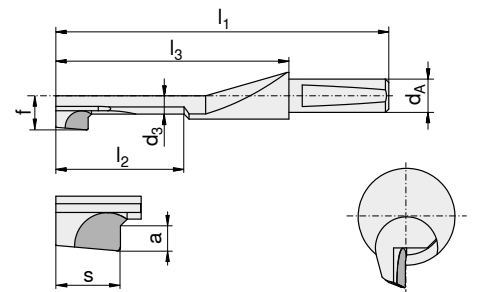
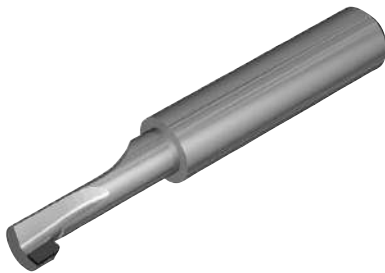

d_A [mm]	Type, designation	LNR 	l_1 [mm]	l_2 [mm]	l_3 [mm]	d_3 [mm]	f [mm]	s [mm]	a [mm]
10	S.AL.D.2050.R.01	R	100	38,5	70	11	10,3	9,7	3,75
10	S.AL.D.2100.R.01	R	100	38,5	70	11	10,5	9,7	4

Stud hole drill

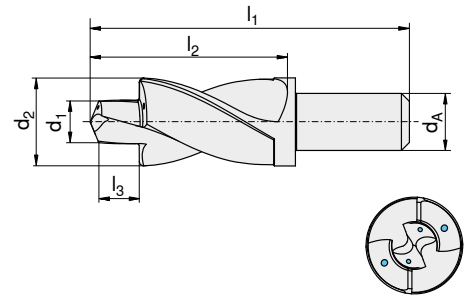
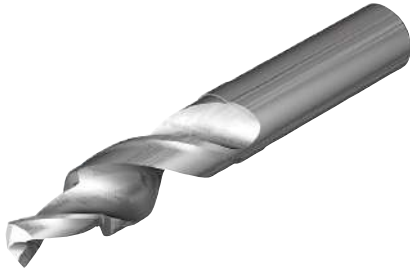

d_A [mm]	Type, designation	l_1 [mm]	l_2 [mm]	l_3 [mm]	d_1 [mm]	d_2 [mm]	d_A [mm]
25	B.AL.C.1910-3860.R.02.I	140	85	18	19,1	38,6	25

Measurement hole drill

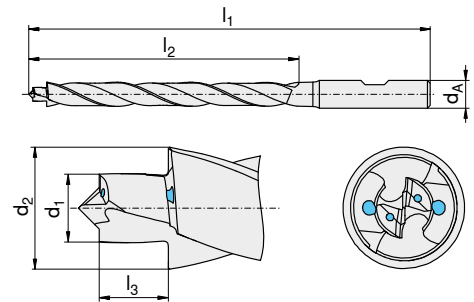
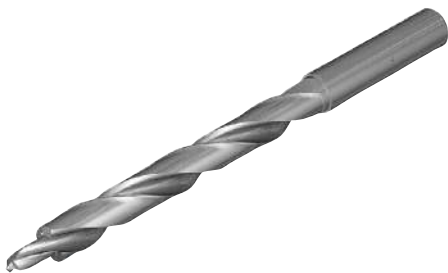

d_A [mm]	Type, designation	l_1 [mm]	l_2 [mm]	l_3 [mm]	d_1 [mm]	d_2 [mm]
10	B.AL.C.0500-0880.R.02.IK	125	85	5	5	8,8
10	B.AL.C.0500-0880.R.02.IK	145	100	5	5	8,8
10	B.AL.C.0500-0920.R.02.IK	145	100	10	5	9,2
10	B.AL.P.0550-0920.R.02.IK	125	85	5	5	9,2

Valve hole drill

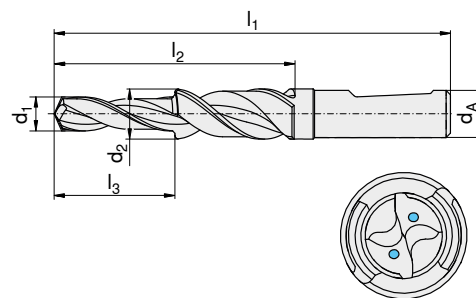
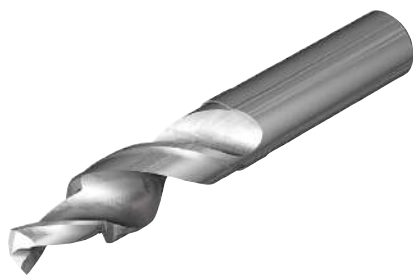

d_A [mm]	Type, designation	l_1 [mm]	l_2 [mm]	l_3 [mm]	d_1 [mm]	d_2 [mm]
16	B.AL.C.1150-1700.R.02.IK	120	67	20	11,5	17
16	B.AL.C.1150-1700.R.02.IK	140	85	40	11,5	17
16	B.AL.C.1150-1700.R.02.IK	125	72	25	11,5	17
16	B.AL.C.1150-1850.R.02.IK	120	67	20	11,5	18,5
16	B.AL.C.1165-1905.R.02.IK	138,5	85	10	11,65	19,05
16	B.AL.C.1165-2000.R.02.IK	138,5	85	10	11,65	20
16	B.AL.P.1150-1675.R.02.IK	125	70	25	11,5	16,75
16	B.AL.P.1150-1845.R.02.IK	120	67	20	11,5	18,45
16	B.AL.P.1165-1550.R.02.IK	141	77	10	11,65	15,5
16	B.AL.P.1165-1710.R.02.IK	151	78	10	11,65	17,1
16	B.AL.P.1165-1725.R.02.IK	144,5	80	10	11,65	17,25
16	B.AL.P.1165-1780.R.02.IK	138,5	80	10	11,65	17,8
16	B.AL.P.1165-1850.R.02.IK	138,5	77	10	11,65	18,5
16	B.AL.P.1165-2000.R.02.IK	147	80	22,5	11,65	20



Machine connections

CERATIZIT offers tool holders for all common machine connections, such as VDI, boring bar, UTS and square-section shank.

In addition, there is the option of making direct connections to all current machines. Thanks to the close relationships between CERATIZIT and the machine manufacturers, a great deal is realised here for initial equipment or optimisation.

Danobat

Shortest possible connection to the NI-750 for the second operation.

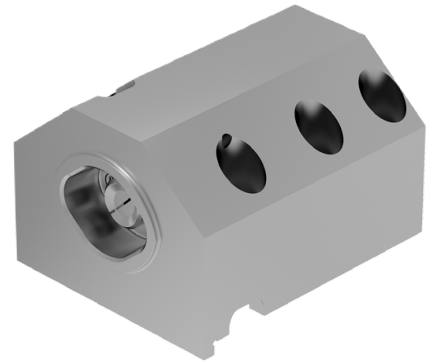

2.5 inch

This connection is present for the majority of larger Okuma machines and enables a simple change to OvalFlex.

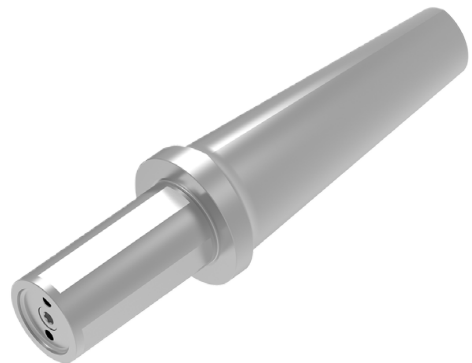

Doosan

Optimal stability and minimisation of vibrations for Doosan machines (e.g. AW560, etc.)



Kuma

Outstanding stability through direct connection to the majority of Okuma machines currently available on the market.

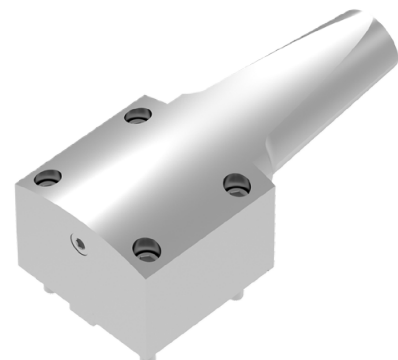

Special tools available at customer request

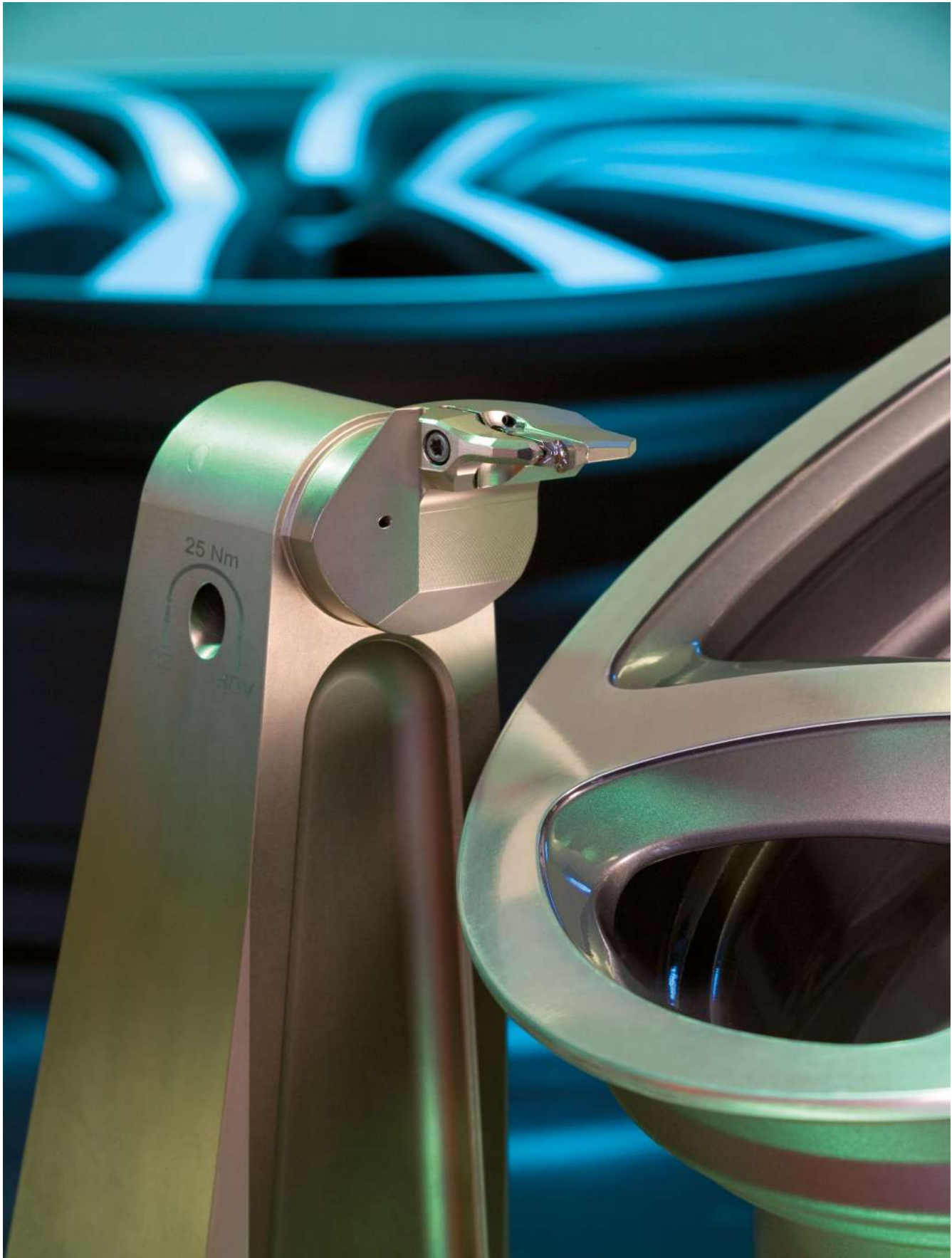

General formulae

Cutting speed (v_c)

$$v_c = \frac{d_1 \cdot \pi \cdot n}{1000} \quad [\text{m/min}]$$

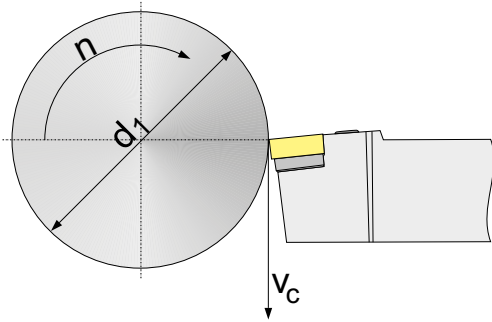

Revolutions per minute (n)

$$n = \frac{v_c \cdot 1000}{d_1 \cdot \pi} \quad [\text{U/min}]$$

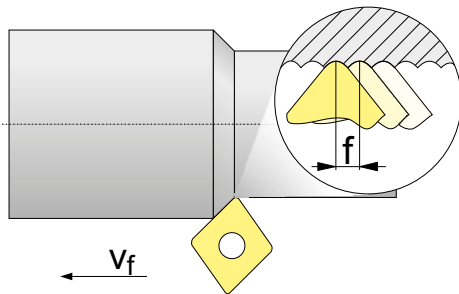

Feed rate (v_f)

$$v_f = f \cdot n \quad [\text{mm/min}]$$

Cutting data standard values

Workpiece material		Treatment / alloy	Relative machinability*	Hardness HB	H210T H216T v_c [m/min]	CTD4110 v_c [m/min]
N	Aluminium Wrought alloy	Hardenable	Al MG Si 1	3-4	100	400 - 2500 400 - 2800
	Aluminium Cast alloy	Non-hardenable	G - Al Si 1	3	50-70	
			G - Al Si 7			
			G - Al Si 11	2-3	80	
			G - Al Si 7 Mg			

* 1 = Very good machinability / 5 = Poor machinability.

The machinability can be defined as the difficulty presented by a material during machining work. Four main indexes are used to evaluate this:

- ▶ Cutting force / ▶ Service life / ▶ Surface quality / ▶ Chip formation

Causes/Types of wear

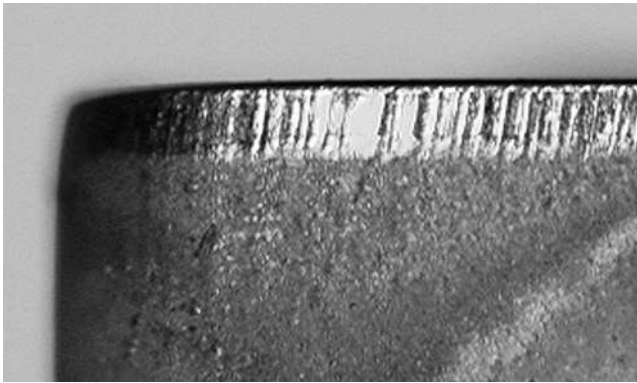

Abrasion on the flank, normal wear after a certain period of operation.

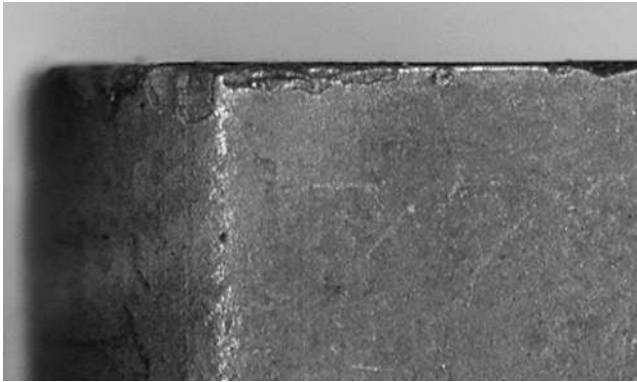

Increased mechanical stress on the cutting edge may result in carbide particles breaking off.



The outgoing hot chip is causing cratering of the cutting insert on the clamping surface.

Flank wear

Cause

- ▲ Cutting speed too high
- ▲ Carbide grade does not have enough wear resistance
- ▲ Feed not adapted to application

Solution

- ▲ Reduce cutting speed
- ▲ Select a carbide grade with a higher wear resistance
- ▲ Bring feed into the right relationship with cutting speed and cutting depth (increase feed)

Edge breakage

Cause

- ▲ Grade with too high a wear resistance
- ▲ Vibration
- ▲ Feed rate or cutting depth is too high
- ▲ Interrupted cut
- ▲ Chip stroke

Solution

- ▲ Use tougher grade
- ▲ Use negative cutting edge geometry with a chip breaker
- ▲ Improve stability (tool, workpiece)

Crater wear

Cause

- ▲ Cutting speed, feed rate or both are too high
- ▲ Rake angle too low
- ▲ Grade does not have enough wear resistance
- ▲ Incorrectly supplied coolant

Solution

- ▲ Reduce cutting speed and/or feed rate
- ▲ Increase amount or pressure of coolant, check supply
- ▲ Use crater-resistant grades

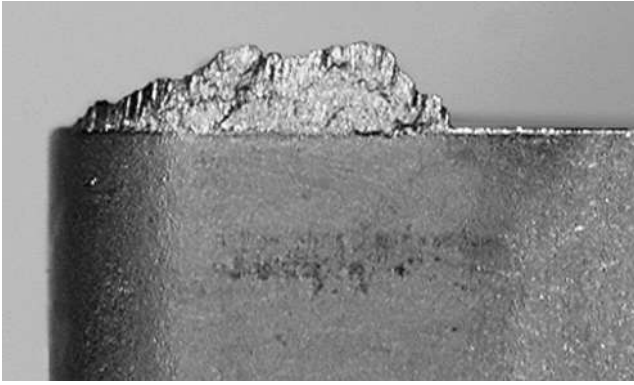

Material builds up on the cutting edge if the chip does not flow correctly due to the cutting temperature being too low.

Built-up edge formation

Cause

- ▲ Cutting speed too low
- ▲ Rake angle too small
- ▲ Incorrect cutting material
- ▲ Missing coolant/lubrication

Solution

- ▲ Increase cutting speed
- ▲ Increase rake angle
- ▲ Use coating
- ▲ Use thicker emulsion

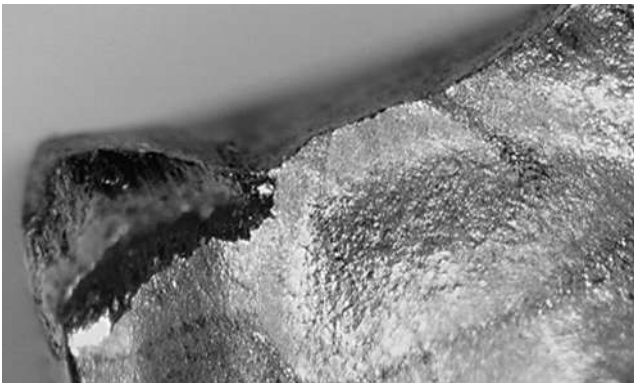

If a cutting insert is overloaded, insert breakage may occur.

Insert breakage

Cause

- ▲ Overload of the cutting material
- ▲ Lack of stability
- ▲ Wedge angle too small
- ▲ Excessive notch wear

Solution

- ▲ Use a tougher cutting material
- ▲ Use chamfer for edge protection
- ▲ Increase rounding of cutting edge
- ▲ Use more stable geometry

Put pressure on costs with CERATIZIT

Composition of workpiece costs

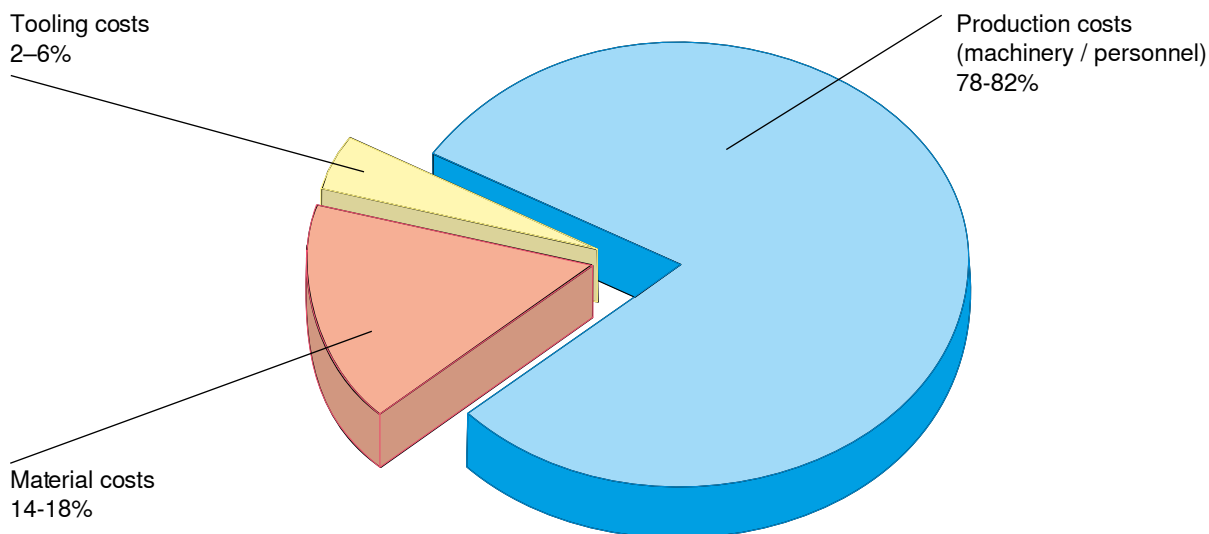

Increase in productivity (produced parts per time unit):

Increase in productivity (produced parts per time unit)

Considerable savings in unit costs can be achieved through better use of the existing machine capacity. CERATIZIT EcoCut makes a vital contribution here, with:

- Fewer tool changes
- Increase of v_c
- Increase of f
- Increase of a_p

+30% increase in productivity

results in a

-19% reduction in unit costs

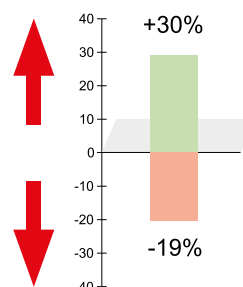

Extended service life:

Extended service life

As, on average, the tool costs only account for 2-6% of the unit costs, the reduction in unit costs to be expected through extending service life is generally less than 1%.







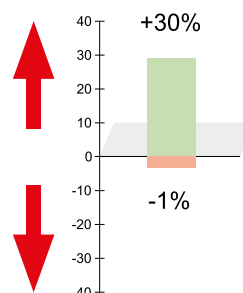

+30% increase in service life

results in a

-1% reduction in unit costs



Recommended tightening torques

Screw	Explanation	Tightening torque	
		Nm	in .lbs
M16	 OC50 power screw, axial clamping	50	442
M8	 OC50R power screw, radial clamping	25	221
M5	 Torx 25 clamping finger screw X32	8	71
M6	 M6 DIN 912 clamping finger screw X32	12	106
M4.5	 Torx 20 HubStar	6	53
M4.5	 V22 inserts	5	44.3
M3.5	 V16 inserts	3.5	31
M3	 Button inserts	2	18
M2.5	 V11 inserts	1.2	11

OEM services

OEM

**Everything from a single source:
Tailor-made machining strategies and complete tool packages**

Not only do we offer our partners in an extremely wide range of industrial applications excellent cutting tools, but also tailor-made complete concepts and toolkits for optimal machining of workpieces on your equipment. Our own OEM team is available to coordinate and support your project. For new materials or particularly difficult workpieces, Tooling Academies at our production sites and several Technical Centres at our sales offices are ready to carry out machining tests. In this way, we are able to guarantee you the utmost professionalism and reliability, as well as solutions individually tailored to your requirements. Working together with you, we

develop detailed machining concepts and support you with implementing these directly on the machinery at your site – worldwide. We support you in process optimisation as well as in realising new projects. Get in touch.



With the CERATIZIT OEM services, we offer you the following specific services:

- ▲ Advice on workpiece clamping and the machining strategy
- ▲ Definition of the individual machining steps
- ▲ Selection of the optimal tools, cutting edge geometries and cutting materials
- ▲ Where necessary, trial machining in one of the CERATIZIT Tooling Academies or one of the Technical Centres
- ▲ Determination of cutting forces and spindle power – mathematically or through measuring the cutting forces
- ▲ Establishment of cutting parameters
- ▲ Calculation of machining times and unit costs
- ▲ Forecast of tool service lives and tool costs
- ▲ Tool assembly and measurement
- ▲ Support during preliminary and final acceptance of machines
- ▲ Comprehensive project documentation
- ▲ Effective project and deadline management

Behind every OEM project is an experienced, multifunctional team of experts from all necessary specialist areas: project management, sales, customer service, application technology, design, logistics and production.

As a result, we are able to guarantee you professional services for the provision of original equipment machinery and process optimisations, as well as a reliable collaboration based on partnership.



Complete and clear project documentation



The project documentation sets out the entire machining concept in full, in a clearly-structured manner: machining steps and tool assignment, machining plans, cutting

parameters, power and time calculations, tool sheets with reference dimensions and parts lists, as well as, of course, the tool package with prices and delivery times.

CERATIZIT Deutschland GmbH
D-72108 Esslingen
www.ceratizit.com
Together we create the better solution

CUTTING SOLUTIONS BY
CERATIZIT

Customer: Project: Demo Titanium machining O-000487 / Date: 05.09.2016

Machining study: Work piece 1			Set-up 1													Machine 1							
No.	Type	Description	Assembled Tool			Dimensions					Cutting data					Surface		Time calculation					
			No.	c	z	Spindle	D	d	L	r ₁	r ₂	n	f _s	v _c	f _p	a _p	l	A _c	t	t ₀	t ₁	t ₂	
						mm	mm	mm	mm/min	mm ²	m/min	mm/min	mm	mm	mm	mm	mm ²	min	min	min	min	%	
1	Milling	Face roughing	M6-001	1	10	1	125	0	900	95	140	0.25	350	4.5	100	1	1.23	2.57	0	2.97	100		
2	Milling	Face contour roughing	M6-002	1	5	1	63	0	350	95	277	0.35	455	4	53	4	0.48	7.84	0	7.84	100		
3	Drilling	Center hole	DR-001	1	1	1	44	0	88	70	505	0.07	35	0	0	1	0	2.49	0	2.49	100		
4	Drilling	Near exit hole	DR-001	1	1	1	44	0	80	70	505	0.07	35	0	0	4	0	5.2	0	5.2	100		
5	Milling	First step pocket roughing	M6-003	1	3	1	32	0	340	45	447	0.1	134	25	32	4	0.08	10.14	0	10.14	100		
6	Milling	Second step pocket roughing	M6-003	1	3	1	32	0	340	45	447	0.1	134	25	32	4	0.08	10.14	0	10.14	100		
7	Milling	Carrier flange roughing	M6-003	1	3	1	32	0	230	45	447	0.1	134	40	12.75	1	0.08	1.72	0	1.72	100		
8	Milling	Inside face roughing	M6-003	1	3	1	32	0	300	45	447	0.1	134	4	10	1	0.08	2.24	0	2.24	100		
9	Milling	Center profile hole roughing	M6-003	1	3	1	32	0	270	45	447	0.1	134	25	6.25	1	0.08	2.01	0	2.01	100		
10	Milling	Outside wall roughing	M6-003	1	3	1	32	0	570	45	447	0.1	134	25	5	2	0.08	12.98	0	12.98	100		
11	Milling	Face finishing	M6-004	1	6	1	20	0	840	80	1273	0.06	362	1	5	1	0.38	2.2	0	2.2	100		
12	Milling	Inclined surface breaking	M6-004	1	5	1	20	0	80	80	1273	0.06	362	1	5	4	0.38	0.93	0	0.93	100		
13	Milling	Inside face finishing	M6-004	1	5	1	20	0	290	80	1273	0.06	362	1	5	1	0.38	0.78	0	0.78	100		
14	Milling	Outside wall finishing	M6-004	1	5	1	20	0	840	80	1273	0.06	362	25	0.5	2	0.38	4.4	0	4.4	100		
15	Milling	Pocket wall finishing	M6-005	1	4	1	20	0	340	80	1273	0.06	306	41	0.5	1	0.03	1.11	0	1.11	100		
16	Milling	Pocket bottom finishing	M6-005	1	4	1	20	0	580	80	1273	0.06	306	1	12	4	0.03	7.59	0	7.59	100		

Legend: P₀ = tool and position on tool, c = number of cutting edges on a tool with
L = cutting length, L₀ = diameter, L₁ = tool length, L₂ = percentage of L, D = set-up time

Machining study

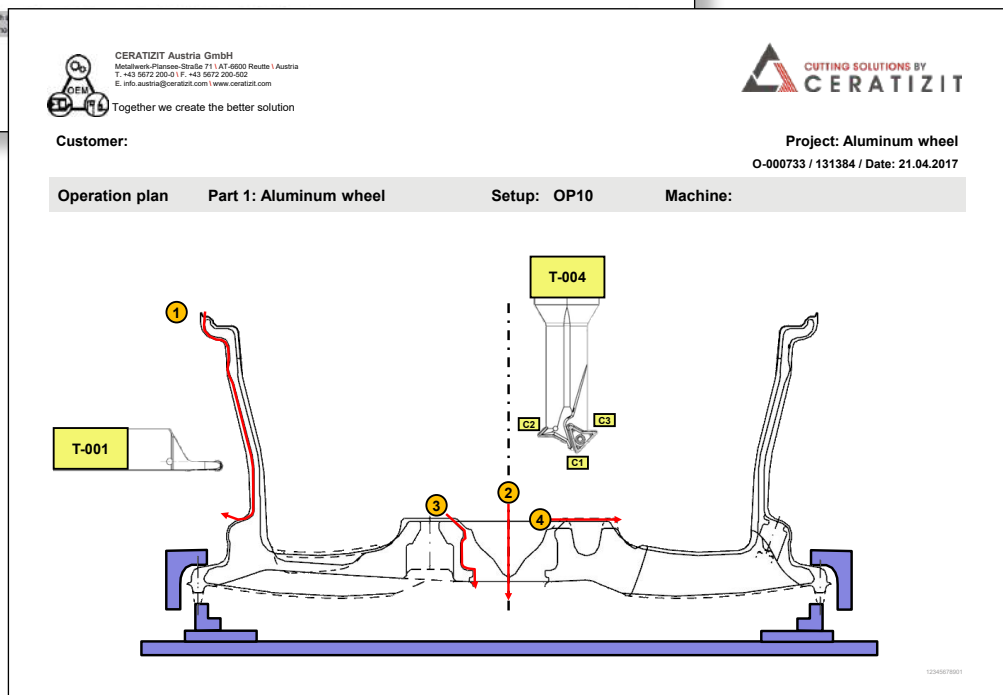

Machining plans

Industry solutions & technical manuals

Changed markets, new technologies and the development of complex materials mean that whole segments of industry are faced with major challenges – from the automotive industry and the energy sector to aviation and aerospace. As a creative and competent partner, we will work with you to develop sector-specific applications and individual solutions. Information on the individual segments, including detailed technical information, grade descriptions, cutting data, valuable application tips and correct usage data can be found in the Technical Manuals.



Download from
www.ceratizit.com

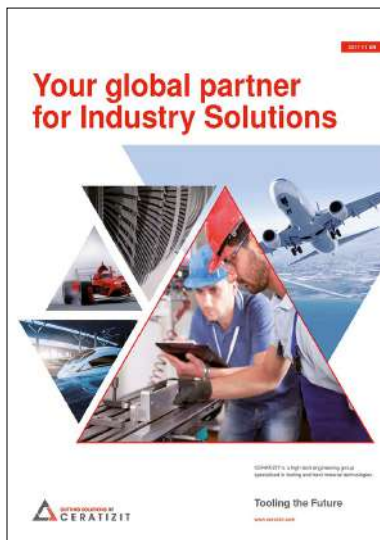

CatalogueNo. 705
Complete Catalogue - Cutting Tools



CatalogueNo. 703
Technical Manual - Brake Disc



CatalogueNo. 679
Technical Manual - Bar Peeling



CatalogueNo. 702 Technical
Manual - Heavy Machining

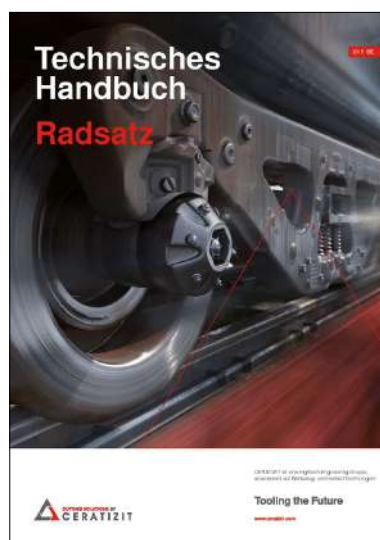

CatalogueNo. 668
Technical Manual - Wheelset



CatalogueNo. 667
Technical Manual -
Hard Machining with PCBN

Notes

Notes

Headquarters:

CERATIZIT S.A.
LU-8232 Mamer
T. +352 31 20 85-1
E. info@ceratizit.com

www.ceratizit.com

Austria

CERATIZIT Austria GmbH
AT-6600 Reutte
T. +43 5672 200-0
E. info.austria@ceratizit.com

Brazil

CERATIZIT América Latina Ltda.
BR-06453-002 Barueri, São Paulo
T. +55 11 4133 2300
E. info.americalatina@ceratizit.com

Bulgaria

CERATIZIT Bulgaria AG
BG-5301 Gabrovo
T. +359 66 812 206
E. info.bulgaria@ceratizit.com

China

CB-CERATIZIT Tianjin
CN-300384 Tianjin
T. +86 22 5810 7000

Czech Republic / Slovak Republic

CERATIZIT Office Czech Republic
CZ-594 01 Velké Meziříčí
T. +420 566 520 341
E. info.czechrepublic@ceratizit.com

France / Luxembourg / Belgium

CERATIZIT Luxembourg S.à r.l.
LU-8232 Mamer
T. +352 31 20 85-1
E. info@ceratizit.com

Germany

CERATIZIT Deutschland GmbH
DE-72186 Empfingen
T. +49 7485 99802 0
E. info.deutschland@ceratizit.com

Great Britain

CERATIZIT Office UK
UK-Sheffield S9 1XU
Toll Free 0800 048 4877 / 4878
T. +44 1925 261 161
E. info.uk@ceratizit.com

Hungary

CERATIZIT Office Hungary
HU-1138 Budapest
T. +36 1 437 0930
E. info.hungary@ceratizit.com

India

CERATIZIT India Pvt. Ltd.
IN-Bengaluru 560099
T. +91 80 4043 1262
E. ctindia.south@ceratizit.com

CERATIZIT India Pvt. Ltd.

IN-Chennai 600037
T. +91 44 4269 4350
E. ctindia.south@ceratizit.com

CERATIZIT India Pvt. Ltd.

IN-Coimbatore 641009
T. +91 4224 273 373
E. ctindia.south@ceratizit.com

CERATIZIT India Pvt. Ltd.

IN-Gurgaon 122002
T. +91 124 4018 481
E. ctindia.north@ceratizit.com

CERATIZIT India Pvt. Ltd.

IN-Pune 411018
T. +91 20 6529 0628
E. ctindia.west@ceratizit.com

Indonesia

CB-CERATIZIT Indonesia
ID-17530 Bekasi
T. +62-21-2961-2351

Italy

CERATIZIT Italia S.p.A.
IT-22040 Alserio (CO)
T. +39 031 6349 211
E. info.italia@ceratizit.com

Mexico

CERATIZIT México, S.A. de C.V.
MX-76040 Querétaro, QRO
T. +52 442 225 9173
E. info.mexico@ceratizit.com

Netherlands

CERATIZIT Nederland B.V.
NL-4707 AT Roosendaal
T. +31 165 55 08 00
E. info.nederland@ceratizit.com

Poland

CERATIZIT Office Poland
PL-30-443 Kraków
T. +48 12 252 8591
E. info.polska@ceratizit.com

Spain / Portugal

CERATIZIT Ibérica S.L.
ES-28031 Madrid
T. +34 91 351 0609
E. info.iberica@ceratizit.com

Taiwan

CB-CERATIZIT Tamsui
TW-25152-Tamsui
T. +886 2 2622 1668

Turkey

CERATIZIT Turkey
TR-34870 Kartal, İstanbul
T. +90 216 353 66 43
E. info.turkey@ceratizit.com

USA / Canada

CERATIZIT USA, Inc.
US-Warren, MI 48089-1833
Toll free +1-800-783-2280
T. +1-586-759-2280
E. info.usa@ceratizit.com

