



CUTTING SOLUTIONS BY CERATIZIT

USER MANUAL

WHEEL SET MACHINING

EN

CUTTING SOLUTIONS BY CERATIZIT

USER MANUAL

WHEEL SET MACHINING



Dear customers,

More than 100 years of experience in machining make us one of the most knowledgeable providers in this industry. From new wheel production and axle production to wheel rework and bogie machining, we are a reliable partner to our customers in the rail and rolling stock industry. Our international company structure brings us into close contact with companies based all over the world and helps us to understand local conditions and their precise needs. Close cooperation with manufacturers of wheelset machining components and machinery also helps us advance our knowledge and develop highly effective tool solutions that deliver the ultimate in performance. As a result, our high-quality cutting material solutions and tools for turning, drilling and milling are a guarantee for the very best quality and process security. We are here to help you with expert advice and would be delighted to introduce you to our impressively wide range of tools.

Your CERATIZIT team



Cutting solutions by CERATIZIT		2–19
	CERATIZIT highlights	6–9
	Services	10–11
	Carbide production	12–13
	Wheel set machining – overview	14–15
	Standard tools and inserts	16–17
	Special solutions	18
	Connection systems	19
New wheel production		20–39
	Overview, requirements	22–23
	Materials	24
	Cutting material grades	25
	Process, machining examples	26–31
	Tool holders	32
	CERATIZIT clamping system	33
	Inserts	34–39
Axle production		40–61
	Overview, requirements	42–43
	Materials	44
	Cutting material grades	45
	Process, machining examples	46–49
	CERATIZIT standard tools	50–51
	Inserts	52–61
Wheel reprofiling		62–81
	Overview, requirements	64–65
	Materials	66
	Cutting material grades	67
	Process, machining examples	68–69
	Tools, tool holders, cartridge systems	70–71
	CERATIZIT cartridge systems	72–75
	Inserts	76–81
Bogie machining		82–89
	Overview, requirements	84–85
	Process	86
	Drills	87
	Milling cutters – face milling	88
	Milling cutters – shoulder and slot milling	89
CERATIZIT OEM services - complete process solutions		90–97
	CERATIZIT OEM services	92
	Operation plan	93
	Machining study	94
	Tooling studies	95
	Tooling elements	97
Index		98–100
	Index	98

CERATIZIT – passion and pioneering spirit for carbides

For over 95 years, CERATIZIT has been a pioneer developing exceptional hard material products for cutting tools and wear protection. The privately owned company, based in Mamer, Luxembourg, develops and manufactures highly specialised carbide cutting tools, inserts and rods made of hard materials as well as wear parts. The CERATIZIT Group is the market leader in several wear part application areas, and successfully develops new types of carbide, cermet and ceramic grades which are used for instance in the wood and stone working industry.

With over 9,000 employees at 34 production sites and a sales network of over 70 branch offices, CERATIZIT is a global player in the carbide industry. As a leader in materials technology, CERATIZIT continuously invests in research and

development and holds over 1,000 patents. Innovative carbide solutions from CERATIZIT are used in mechanical engineering and tool construction and many other industries including the automotive, aerospace, oil and medical sectors.

The internationally active CERATIZIT Group unites the four competence brands Cutting Solutions by CERATIZIT, Hard Material Solutions by CERATIZIT, Tool Solutions by CERATIZIT and Toolmaker Solutions by CERATIZIT. The carbide expert also includes the subsidiaries WNT and CB-CERATIZIT, as well as the tool manufacturers Günther Wirth, PROMAX Tools, Klenk, Cobra Carbide India, Becker Diamantwerkzeuge, Best Carbide Cutting Tools and KOMET GROUP.

Facts & figures

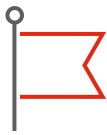

1 headquarter
Mamer, Luxembourg

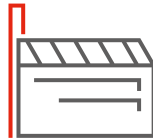

34
production sites



> 70
sales subsidiaries



> 9,000
employees



> 100,000
different products



> 1,000
patents and
utility models



> 200
employees in R&D



> 10
innovation awards



30%
of products
developed in the last 5 years

> **65,000** ARTICLES
AVAILABLE IN STOCK 

> **3,000** ORDERS
PER DAY

3 MIN. FROM THE INCOMING ORDER
TO THE READY-FOR-TRANSPORT PACKAGING

ORDER BY **6:30pm** WITH GUARANTEED
DELIVERY ON THE FOLLOWING DAY 

JUST IN TIME

MINIMISATION
OF TOLL AND SHIPPING COSTS

INTRODUCTION

CERATIZIT HIGHLIGHTS

The CERATIZIT highlights

Best possible quality and top-class customer service are our goal: with CERATIZIT the railway and rolling stock industry has a partner who guarantees quality standards and elaborates innovative solutions in dialogue with customers. Benefit from

the extensive expertise that CERATIZIT specialists pass on to you in training courses with highly qualified staff, and let us help you find new and even more efficient tooling solutions. We will be happy to give you our full support!

Guaranteed quality standard

As we at Cutting Solutions by CERATIZIT manage the entire process chain of carbide production whilst also constantly ensuring precision and performance at the highest level. Our quality promise to you is a premium-class cutting tools solution with maximum tool life and optimal process security, which guarantees added value both technically and economically.

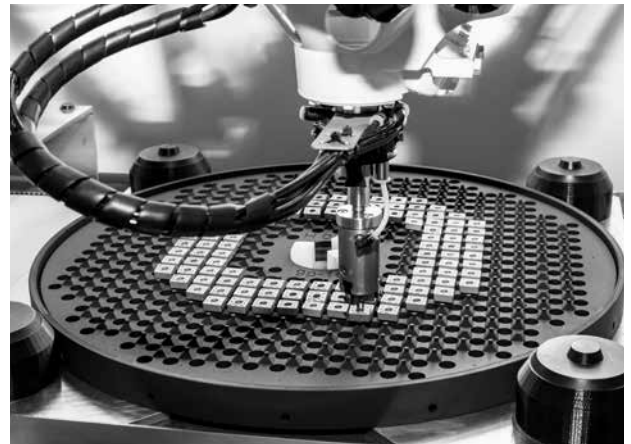

Universal expertise in solutions

As the products we supply will increase the economic efficiency of your production – from standard tools with an attractive price-performance ratio, to industry-specific and individually customised product innovations. As a creative partner, we consult with you and therefore understand what your requirements are. Accordingly, we develop the right solution for your challenges.



Reliable logistics

As you benefit from a logistics centre which sets standards throughout the world and keeps costs low thanks to harmonised processes. Rely on maximum availability of the products which we deliver you in minimum time and just in time to your desired destination.

Top-class service

Because we make it possible for you to expand your knowledge of your tools and machining processes at our test and training centres. This results in your production becoming even more efficient and forms the basis for the development of new tooling solutions in partnership with us.



Competent dialogue

As your consultant partners and application engineers, we speak your language and provide support enriched by knowledge, experience and passion. Our expertise in solutions will be evident in our consultation with you: it is always our top priority to understand your requirements in order to find the best solutions in cooperation with you. Just speak to the distribution partner closest to you.

CERATIZIT standard tools and inserts

The CERATIZIT GROUP has the metallurgical expertise to control the entire process chain of carbide production: from raw materials production and powder preparation to forming, sintering and finishing, we can make the right adjustments at

any time and adapt the material properties to your individual requirements. Just talk to us about your future projects!

Online service

Of course, we are also here for you online – 24 hours a day!

On the CERATIZIT website, you will not only find all the details on our innovative products, but can also order these products straight away.

Within the various product ranges, you have access to over 80 product details pages from the fields of machining, rods & moulded parts, wear protection and wood & stone working. Discover product videos, application examples and success stories.

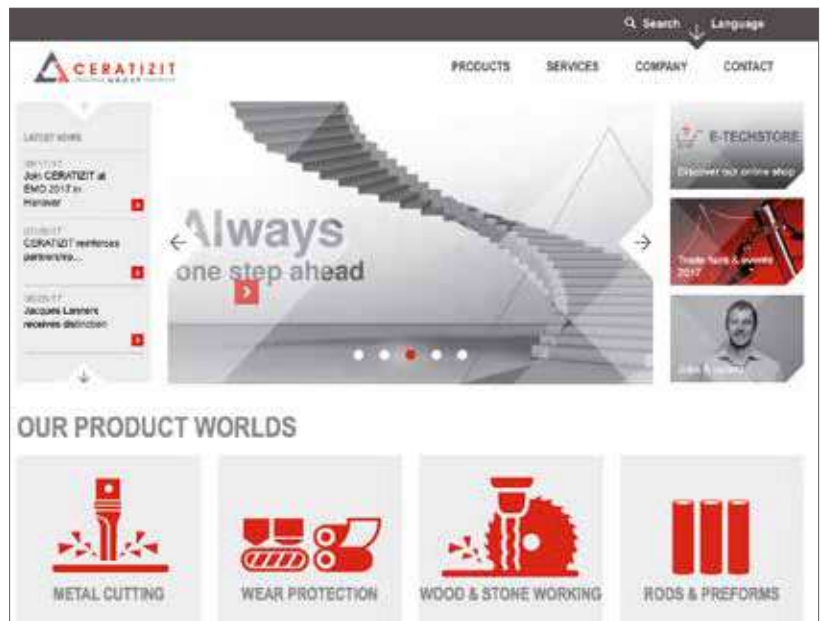

Online shop – E-Techstore

The majority of our standard products are available from stock. Our well organised warehouse guarantees that your order will be processed quickly and reliably, even if it is for large quantities. Thanks to our modern supply chain management, our production capacities are flexible. We are therefore able to manufacture very large quantities in a very short period of time.

You can order products that are in stock from our online e-techstore, 24 hours a day.





Tooling Academy

Make use of the fund of knowledge we have amassed at the CERATIZIT cutting tools centre. Here we subject tools and new developments to comprehensive endurance tests under realistic conditions. To ensure high-quality and economical production, all components – machine, spindle and tools – must be optimally coordinated. Should there be issues in a particular field, our experts can recommend the best tools for the purpose or develop a specific tool for you. Our application engineers and specialists look forward to sharing their knowledge with you – this is why the Tooling Academy organises customer-specific seminars and workshops regularly.

OEM services

You will receive not only excellent cutting tools, but also customised complete solutions and tooling packages for optimal machining of entire work pieces on your machine.

Every project is supported by a large team comprising various specialisations and fields of expertise: whether you are talking to a project director, field service or office employees, engineers, designers, workers in production or logistics – you will benefit from the full range of services of an international company with a worldwide service network.

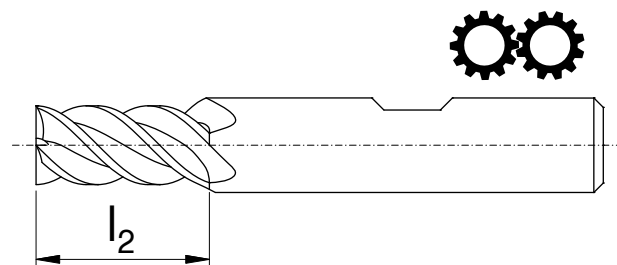

Configure service

Your tailor-made tool. Using the Configure online solution, a tailor-made semi-standard tool can be configured with just a few clicks of the mouse. With the new Configure tool, we offer you a quick and easy ordering process for solid carbide tools adapted to individual customer's requirements. In our e-techstore, you can create your tailor-made semi-standard tool with just a few clicks of the mouse – 24 hours a day, seven days a week!

Restore service

Re-grinding service for standard, semi-standard and special tools. Place your trust in the world-renowned and consistently high product quality of Cutting Solutions by CERATIZIT and the reliable service. This also includes re-grinding of solid carbide tools. Naturally, the prices for our restore service are also calculated fairly and transparent.



CERATIZIT – the carbide concept for success

Carbides are used today in numerous industries and production processes, and have become indispensable too for wheel set machining. Complex products and modern materials make ever higher demands on the tools and materials and call for machining accuracy.

Hard materials are composite materials consisting of hard material and a very tough binder metal. They are exceptionally hard, and offer high wear resistance and heat resistance. Carbide is used wherever tools or components are exposed to high wear, as is the case when machining hard materials. CERATIZIT's composite carbides enhance the quality of the tools and parts, guarantee an extended tool life and ensure process reliability.

Carbides from CERATIZIT consist of a particularly hard tungsten carbide and a comparatively soft binder metal, such as cobalt. The two substances are mixed in the form of powder. CERATIZIT offers more than 130 carbide grades with different compositions. We have the ideal solution for every application and industry.

CERATIZIT commands the entire process chain – from powder preparation to forming, sintering, to finishing and surface

treatment. The blanks are subjected to grinding, polishing and erosion and are subsequently provided with innovative wear protection coatings to ensure that the product has the required technical characteristics.

To make a ready-to-use carbide blank from the powder mixture, first it has to be pressed into a mould. The resulting green carbide blank can then be machined. But only after the sintering process (involving temperatures between 1,300 and 1,500 degrees Celsius and a pressure of up to 100 bar) does it become a homogeneous and dense carbide.

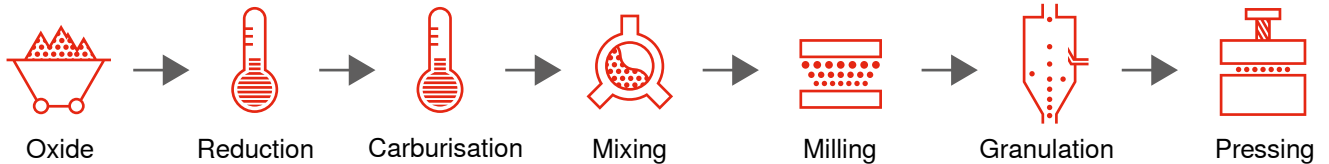

Carbide - a composite material with valuable properties

Both the metal binder content and the grain size of the tungsten carbide influence the performance characteristics of the carbide. The specific composition determines the hardness, transverse rupture strength and fracture toughness of the resulting material. The tungsten carbide grains have an average size of 0.5 to several micrometres (μm). The softer binder, cobalt, fills the gaps between the carbide grains.

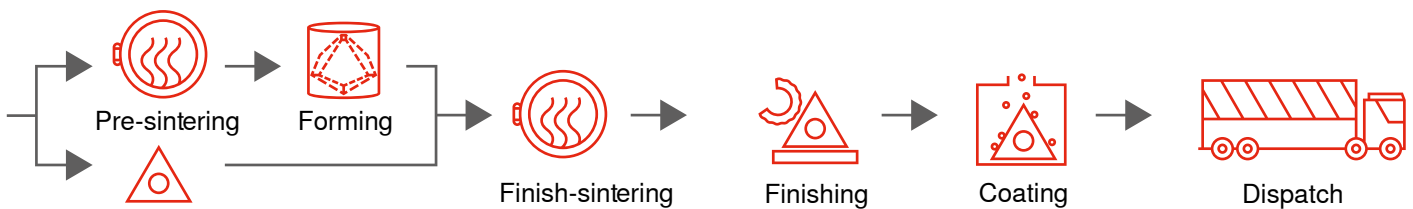
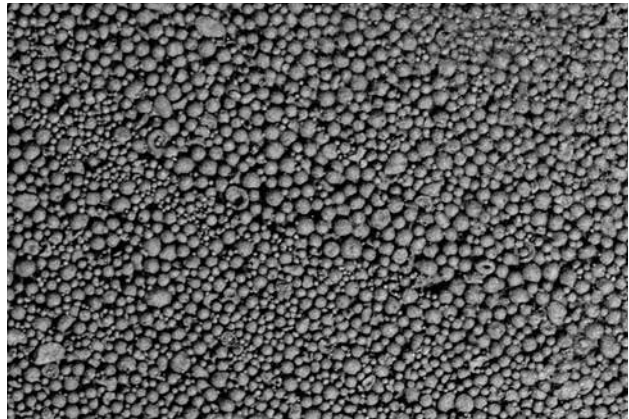

On the one hand, when extremely high toughness is required, the cobalt content can amount up to 30%. On the other, the cobalt content is reduced and the grain size decreased to the submicron range (for example $0.3 \mu\text{m}$), in order to guarantee maximum wear resistance.

CERATIZIT produces far more than 100 different carbide grades particularly for wear parts and cutting tools, thus offering a customised solution for every one of your applications in wheel set machining.



Wheel set machining

Wheels, axles and bogies of trains and other rail vehicles must measure up to the highest quality standards in order to ensure a maximum of operational safety. Covering thousands of kilometres on widely varying routes and carrying heavy loads, train wheels and other wheel set components are however subject to great stress, and the wear suffered is equally

extreme. The service life of wheels and wheel sets is crucially dependent on a high standard of manufacturing quality and regular servicing. Particularly important in this connection are the running surfaces of the wheels, as these are responsible for comfort and smoothness of travel.

Your advantages

- ▲ For more than 50 years, CERATIZIT has been supplying cutting tools for the production and reprofiling of wheels and for all areas of wheel set machining.
- ▲ We go on developing our tools and tool holders continuously, so as to be able to meet the requirements and wishes of our customers.
- ▲ With CERATIZIT on your side, you have a reliable partner you can count on.

Your benefits

- ▲ Ultra-modern cutting material solutions and tool holders for all areas of wheel set machining
- ▲ Maximum tool life with the highest standards of process reliability, based on use of tools from our extensive standard programme
- ▲ Tailor-made special solutions and tooling systems customised to your requirements can be supplied on request.

New wheel production

The production of new wheels makes great demands on cutting materials and tools. The challenge in the machining of the wheel forgings is the need to ensure maximum process reliability coupled with a consistently high standard of quality.

Axle production

The demands made on tools and cutting materials in the production of axles for the railway industry are extreme. Maximum surface quality and the greatest possible process reliability need to be guaranteed in order to measure up to mandatory standards.

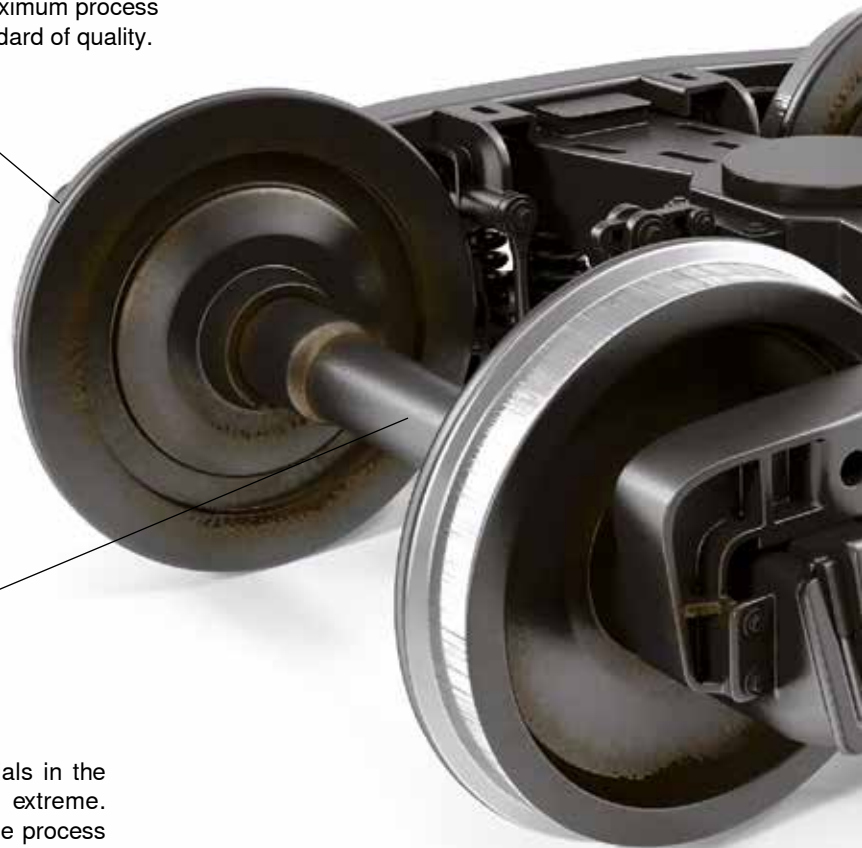



Wheel reprofiling

In the course of daily operation, railway wheels are subjected to enormous pressures. In order to ensure safety and comfort of travel, the geometries of the wheel profiles and deviations must be regularly checked and reprofiled.

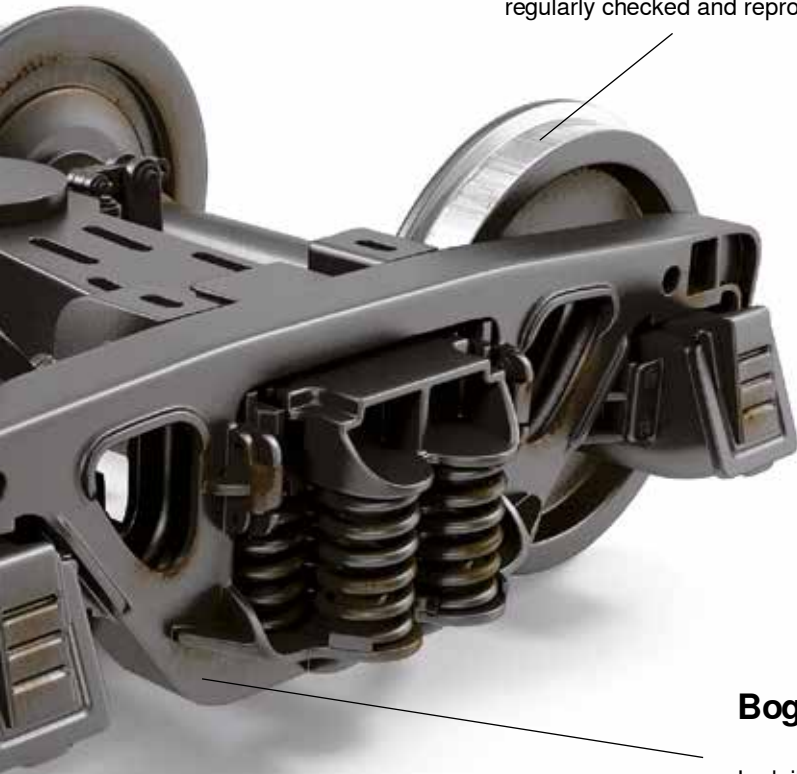

Bogie machining

In daily operation, the bogies of rail vehicles are subject to extreme and varying pressures. Production requirements are thus equally high, in order to guarantee comfort and safety when travelling by rail.

CERATIZIT standard tools

For the machining of wheel sets, CERATIZIT's performance-optimised standard products for turning and milling have proved their effectiveness. In combination with an insert that matches the requirements of the task in hand, these tool holders deliver the best results for the production of new wheels and axles

and wheel reprofiling. The additional clamping, based on a specially designed clamping claw with an indexing system, prevents vibration and movement of the insert in the course of machining. This reduces the incidence of insert breakages.

Your advantages

- ▲ Extensive programme of CERATIZIT standard tools for wheel set machining
- ▲ Reliable process for both wet and dry machining
- ▲ Maximum process reliability

Your benefits

- ▲ Fewer insert breakages
- ▲ Optimised chip flow
- ▲ Ease of handling
- ▲ Maximum tool life
- ▲ Low cost

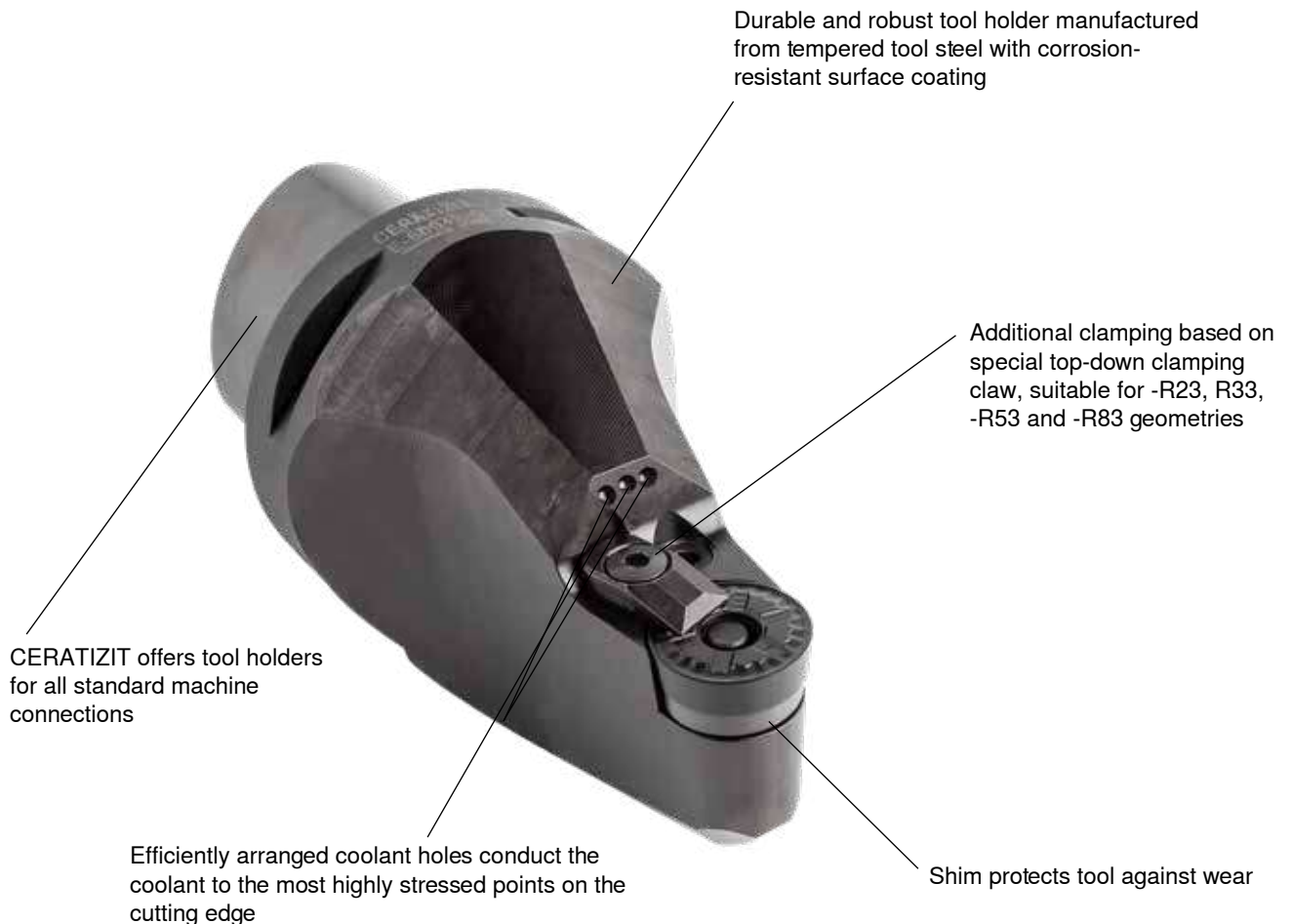

CERATIZIT standard inserts

Inserts from CERATIZIT's standard programme are productive and economical, and guarantee maximum reliability. They are characterised by a high degree of cutting edge stability and high metal removal rates. Depending on the given

requirements, the inserts can be supplied in different cutting material grades and geometries and deliver the best results in wheel set machining, whether for roughing and finishing the wheels and axles or for bogie machining.

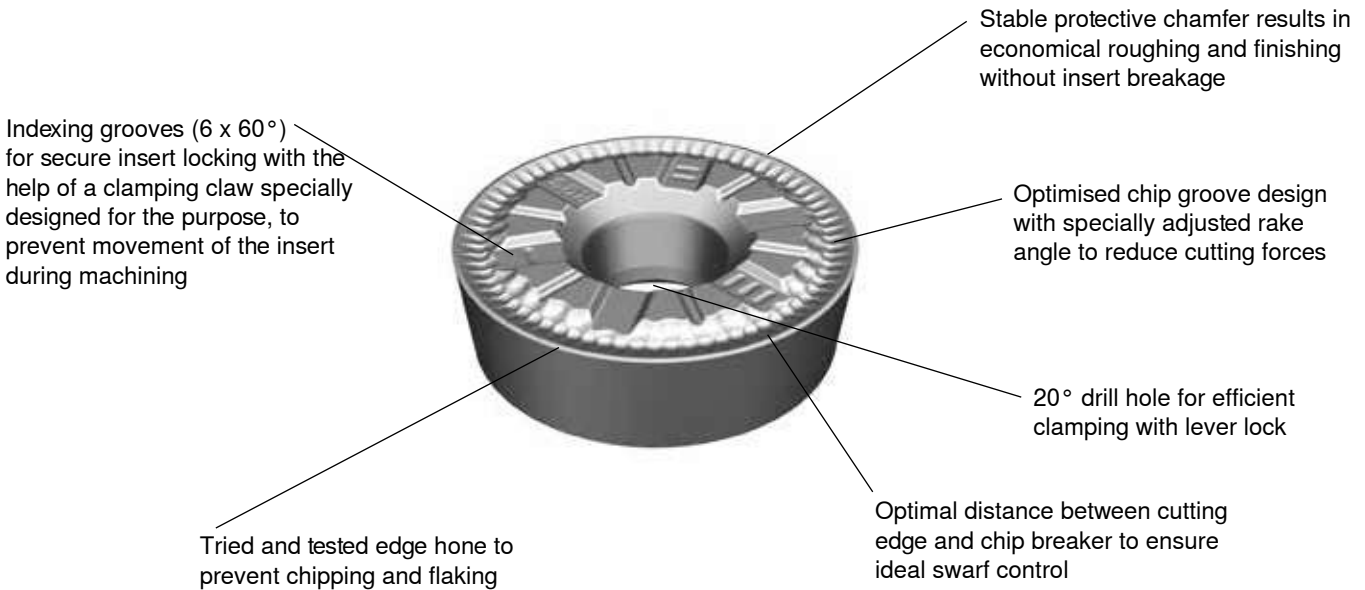

CERATIZIT complete range

CUTTING TOOLS

Many of the tools for wheel set machining are standard tools. With our wide product range of robust turning, milling and drilling tools and our extensive assortment of high-performance carbide drills, you can be sure of finding the ideal equipment to meet your needs.

Detailed information about our standard tools may be found in the current CUTTING TOOLS complete range catalogue. You can download it from the following link:

www.ceratizit.com/en/service/downloads/

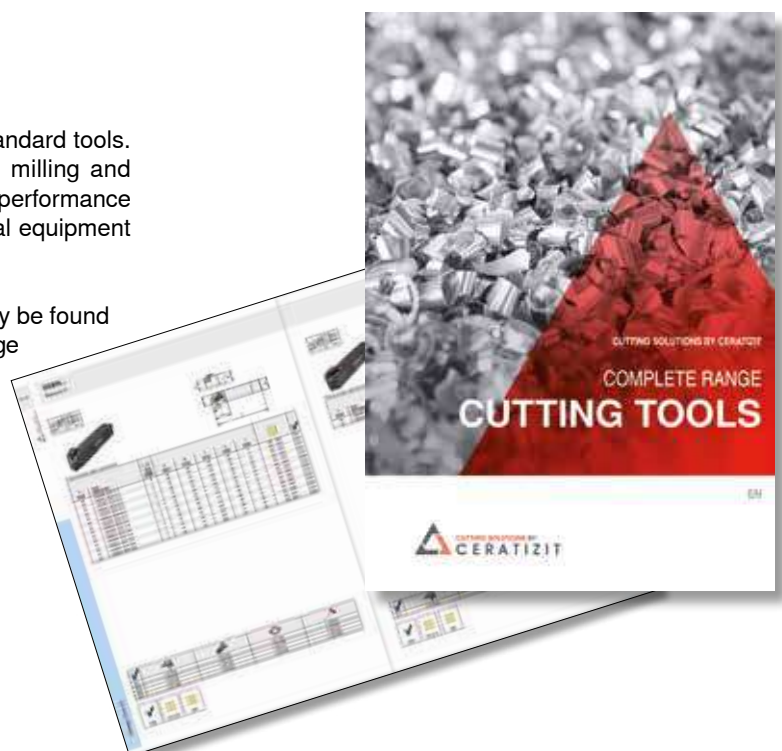

Special solutions

For more than 50 years, CERATIZIT has been a reliable partner to the railway industry in the field of demanding machining technology. Thanks to our expertise in all areas of carbide production, we can guarantee supreme quality for our customers.

In dialogue with our customers we look for innovative solutions for wheel set machining, and develop tools which match your needs and requirements exactly.

Just have a word with us – you can count on our expertise in finding solutions and our powerful and effective products.



Your advantages

- ▲ Fully qualified contact person on site and at the CERATIZIT machining centre
- ▲ Analysis of your requirements
- ▲ Development of innovative solutions
- ▲ Reduced downtime and increase in production thanks to CERATIZIT's complete solutions

Your benefits

- ▲ Individually tailor-made solutions
- ▲ Competitive advantage thanks to innovation
- ▲ Individually manufactured, powerfully efficient tools and suitable inserts
- ▲ Low costs resulting from the perfect interplay of all factors in wheel set machining

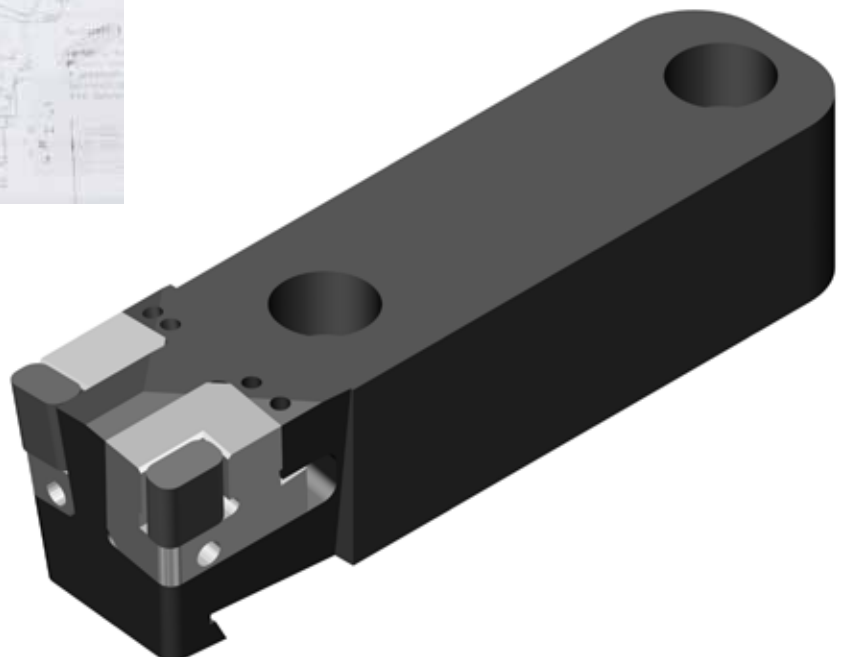

Connection systems

CERATIZIT offers tool holders with all standard connection systems – including for example the polygon adapter (PSC Capto™), HSK-T, UTS and square shanks.

Polygon adapters (PSC Capto™)

- ▲ The advantages of the new CERATIZIT polygon adapters (PSC Capto™) lie in the extreme rigidity and transverse rupture strength. This offers maximum precision, a high degree of repeatability and high torque transmission.



HSK-T

- ▲ HSK-T turning tools for complete machining are characterised by high radial positioning accuracy and precise tip height. HSK-T tool holders are suitable for use with HSK-T and HSK-A spindles, can be clamped in overhead position and come with an optimised coolant supply.



UTS

- ▲ Universal tooling systems (UTS) make it possible to keep tool changing times to a minimum, while adhering to the highest quality and safety standards, resulting in greater productivity.



Square shank

- ▲ The CERATIZIT shank holder for proven conventional clamping.



NEW WHEEL PRODUCTION



New wheel production

The production of new wheels makes great demands on cutting materials and tools. The challenge in the machining of the wheel blanks consists in the need to ensure maximum process reliability coupled with a consistently high standard of quality.



Requirements

Requirements	23
--------------	----

Materials

Materials	24
-----------	----

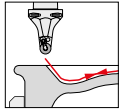

Cutting material grades	25
-------------------------	----

Machining examples

The process	26
-------------	----



Roughing the side profile	27
---------------------------	----



Machining the hub bore	28
------------------------	----



Finishing the running surface	29
-------------------------------	----

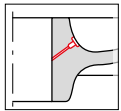

Machining the oil feed hole and web holes	30
---	----

Tooling systems

Tool holders	32
--------------	----



CERATIZIT clamping system	33
---------------------------	----

Inserts

Button inserts	34–35
----------------	-------



90° inserts	36–37
-------------	-------



80° inserts	38–39
-------------	-------

Requirements for new wheel production

After the forging process, railway wheels are given their final form by cutting tools. Cast skins, irregular parts and superfluous material will be removed. The requirements in terms of quality and process reliability are extreme, and the cutting materials and tools thus need to be designed to the highest standards.

Depending on the type of rail vehicle, wheel disks of different sizes are required. The diameter will generally be between 400 and 1600 mm. Likewise the form of the wheel's side profiles or webs may vary. Depending on the use to which the wheels will be put, these may be either straight or undulating. This results in different requirements for the tools and inserts.

The machining of new wheels involves several working steps

on vertical lathes, with either wet or dry machining. The choice of tools and inserts will be dependent on the size, form and material of the blanks. Generally speaking, large button inserts with extremely stable tool holder systems are used. When it is a matter of new wheel production, the railway industry has a reliable partner in CERATIZIT.



Materials in new wheel production

New wheels are made from special tempered steels, with designations such as R1 and R9 for example. Details about the chemical composition and mechanical properties may be found in the following table.

Material designation	Chemical composition [%]											As delivered Heat treatment	Mechanical properties	
	C	Si	Mn	P	S	Cr	Cu	Mo	Ni	V	(Cr+Mo+Ni)		Tensile strength R_m [N/mm ²]	Brinell hardness [HB]
R1	0,48	0,50	0,90	0,035	0,035	0,30	0,30	0,08	0,30	0,05	0,50	N	600–720	178–214
R2	0,58	0,50	0,90	0,035	0,035	0,30	0,30	0,08	0,30	0,05	0,50	N	700–840	208–249
R3	0,70	0,50	0,90	0,035	0,035	0,30	0,30	0,08	0,30	0,05	0,50	N	800–940	238–278
R6	0,48	0,40	0,75	0,035	0,035	0,30	0,30	0,08	0,30	0,05	0,50	T, E	780–900	231–266
R7	0,52	0,40	0,80	0,035	0,035	0,30	0,30	0,08	0,30	0,05	0,50	T, E	820–940	242–278
R8	0,56	0,40	0,80	0,035	0,035	0,30	0,30	0,08	0,30	0,05	0,50	T, E	860–980	255–290
R9	0,60	0,40	0,80	0,035	0,035	0,30	0,30	0,08	0,30	0,05	0,50	T, E	900–1050	266–311

N = tempered
T = wheel and rim, heat-treated
E = entire wheel heat-treated



Cutting material grades for new wheel production

The two CERATIZIT high-performance grades, CTCP115 and CTCP125, cover the entire range of requirements in new wheel machining. They offer excellent wear resistance and maximum process security, and are suitable for both wet and dry machining.

The advantages at a glance

- ▲ Extreme heat resistance
- ▲ High toughness
- ▲ Excellent resistance to notching
- ▲ CVD high-performance layer (maximum hardness, extremely smooth surface)

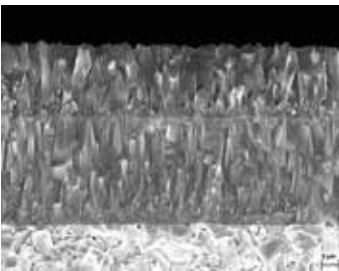
CTCP115 BLACKSTAR™	HC-P15 HC-K25 HC-M10	
	<p>Specification: Composition: Co 5.8%; mixed carbides 6.4%; WC balance Grain size: 1 - 2 μm Hardness: HV₃₀ 1550 Coating specification: CVD TiCN-Al₂O₃</p> <p>Recommended application: The wear-resistant high-performance grade for steel machining</p>	

CTCP 115 – high hardness – ideal for :

- ▲ Slightly interrupted cut
- ▲ Materials with higher strength
- ▲ Higher cutting parameters

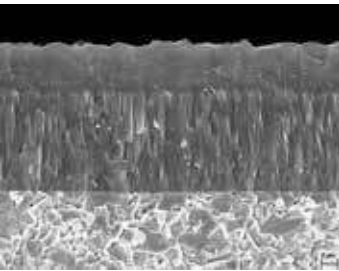
CTCP125 BLACKSTAR™	HC-P25 HC-K30 HC-M20	
	<p>Specification: Composition: Co 7.0%; mixed carbides 8.0%; WC balance Grain size: 1 - 2 μm Hardness: HV₃₀ 1450 Coating specification: CVD TiCN-Al₂O₃</p> <p>Recommended application: The first choice for the universal machining of steel.</p>	

CTCP 125 – high toughness – ideal for:

- ▲ Inconsistent cutting depth
- ▲ Skin on castings or forgings
- ▲ Heavily interrupted cut
- ▲ Materials with medium tensile strength

New wheel production – the process

The machining of new wheels calls for several working steps in two clamping positions. First of all comes the roughing of the wheel rim and the first side profile (the inside of the wheel), then the finishing of the surfaces and the machining of the

hub bore. Then the wheel is turned outside the machine and clamped again on the jaw chuck for the roughing and finishing of the second side profile (the outside of the wheel).

1st clamping position (inside of wheel uppermost)

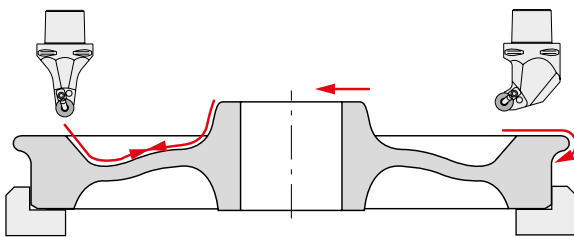

Machining steps

- ▲ Roughing of running surface, wheel rim and side profile (outside of wheel)
- ▲ Finishing of running surface, wheel rim and side profile (outside of wheel)

Recommended inserts

- ▲ Roughing: RCMX -R53, -R83, -R33
- ▲ Finishing: RCMT -M23, -SM
RCMX -R33

2nd clamping position (outside of wheel uppermost)

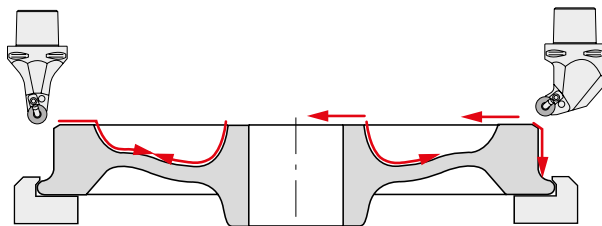

Machining steps

- ▲ Roughing of wheel rim and side profile (inside of wheel)
- ▲ Finishing of wheel rim and side profile (inside of wheel)

Recommended inserts

- ▲ Roughing: RCMX -R53, -R83, -R33
- ▲ Finishing: RCMT -M23, -SM
RCMX -R33

3. Machining the hub bore

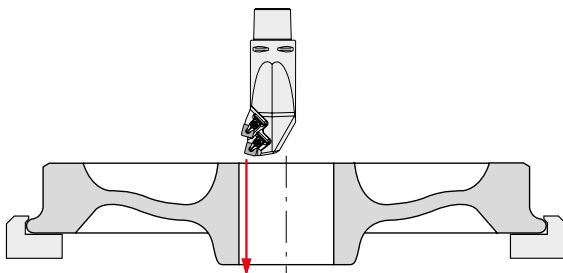

Machining steps

- ▲ Roughing and finishing of the bore

Recommended inserts

- ▲ Roughing and finishing: CNMM -R58, -R88
SNMM -R58, -R88

4. Drilling

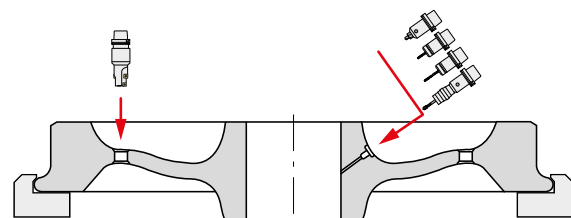

Machining steps

- ▲ Drilling of the oil feed hole
- ▲ Drilling of the fastening bores on the webs

Recommended inserts

- ▲ Drilling: SONT -M30, -R6 special insert
solid carbide step drill
solid carbide high-performance drill h7

Roughing the side profile with the RCMX 3209MOSN-R33

The roughing of the side profiles (webs) is one of the challenges of new wheel production. The machining of large areas, with varying depths of cut and interrupted cut, and the high chip removal rate make great demands on the tools and inserts.

The following machining example contains customer reference values and supplies guide values for this machining step.

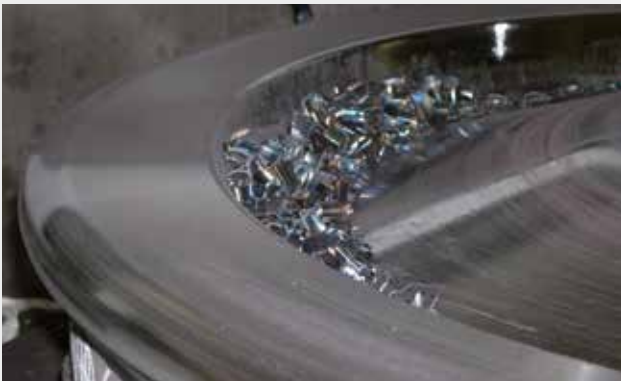

Work piece	railway wheel
Material	R7
Machine	vertical lathe
Tool	C10-DRGCL-32
Insert	RCMX 3209MOSN-R33

Grade	CTCP125
V_c [m/min]	80 – 120
f [mm/rev]	1.0 – 1.4
a_p [mm]	5 – 12
Coolant	emulsion



C10-DRGCL-32



RCMX 3209MOSN-R33



SECURE CLAMPING WITH INDEXED
CLAMPING CLAW



Machining the hub bore with the SNMM 250932SN-R88

In the machining of the hub, precision of the bore is absolutely essential. This calls for speed, surface quality and process reliability, and consequently the roughing of the bore is frequently carried out with appropriate tandem tools in a

single working step. This is made possible by the CERATIZIT -R88 chip groove, as the customer reference values of this machining example well illustrate.



Work piece	railway wheel
Material	R7
Machine	vertical lathe
Tool	DSKNR-2-25
Insert	SNMM 250932SN-R88

Grade	CTCP125
V_c [m/min]	150
f [mm/rev]	1.0
a_p [mm]	5 – 10
Coolant	emulsion



DSKNR-2-25

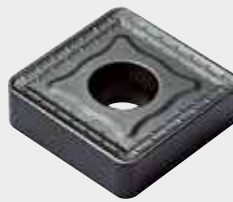

SNMM 250932SN-R88

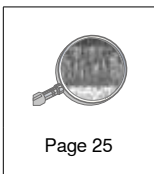

EXTREMELY SMOOTH SURFACE THANKS TO
BLACKSTAR™

Finishing the running surface with the RCMX 2507MOSN-R33

For finishing the running surface and the wheel rim, supreme surface quality is essential. For the fine machining of these surfaces, the recommended tool is the universal CERATIZIT button insert with chip grooves -SM, -R33 and -M23 in the

cutting material grade CTCP115. The following customer reference values supply proven indications for this working step in new wheel production.



Work piece	railway wheel
Material	R7
Machine	vertical lathe
Tool	C10-DRGCL-25
Insert	RCMX 2507MOSN-R33

Grade	CTCP115
V_c [m/min]	220 – 250
f [mm/rev]	1.0 – 1.6
a_p [mm]	0.5 – 1.0
Coolant	emulsion



C10-DRGCL-25



RCMX 2507MOSN-R33



HIGH SURFACE QUALITY THANKS TO OPTIMISED

CHIP GROOVE



Machining the oil feed hole and web holes

In the final machining step of new wheel production, the oil feed hole will be drilled, and where necessary also the fastening bores for the fitting of additional components like driving toothed wheels and wheel brake disks. In this phase

of manufacturing, process reliability is a supreme priority – and here CERATIZIT's tool systems offer the best performance and production safety.

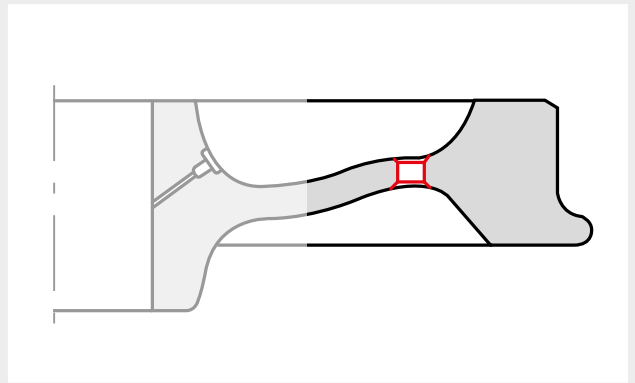
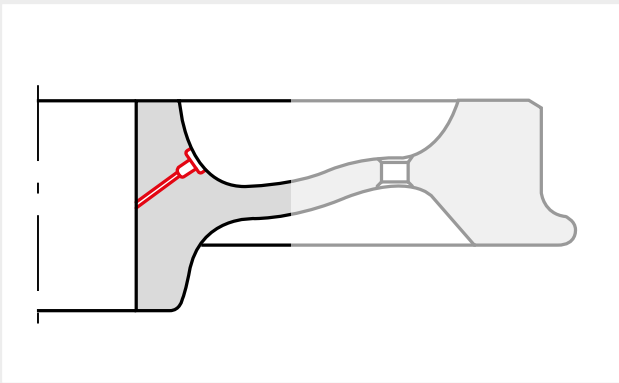

Work piece	railway wheel oil feed hole
Material	R7
Machine	vertical lathe
Tool	MaxiDrill 900 special tool solid carbide step drill solid carbide twist drill solid carbide tap
Insert	SONT 155312ER-M30 CTPP430

Work piece	railway wheel fastening bores
Material	R7
Machine	vertical lathe
Tool	MaxiDrill 900
Insert	SONT 155312ER-M30 CTPP430

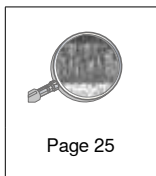

TOOL CONCEPT PROVIDES MAXIMUM
EFFICIENCY





Tool holders with different connection systems

All tools for new wheel production are made to order.

If you are interested in CERATIZIT tools for new wheel production, please send your enquiry to: info.austria@ceratizit.com

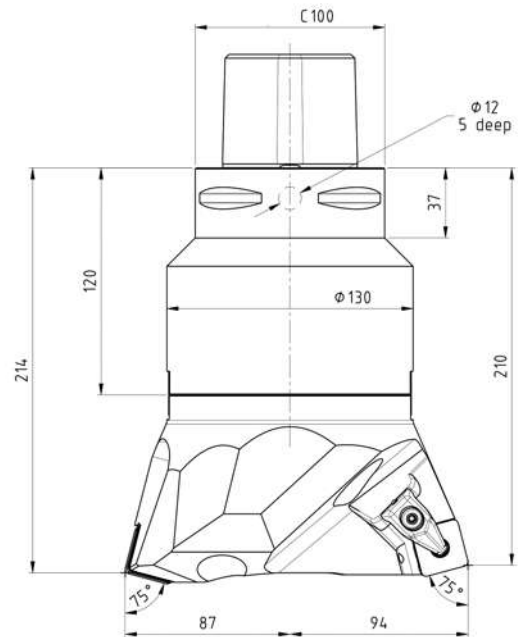

CERATIZIT clamping system

As an addition to the lever lock clamp, the clamping claw system improves process reliability for the processing of new wheels. A special top-down clamping claw with an indexing bulge grips one of the three indexing grooves of the CERATIZIT RCMX inserts, and so prevents any displacement of the insert as a result of vibration during machining.

Advantage

- ▲ Additional clamping security thanks to special top-down clamping claw, matching the -R33, -R53 and -R83 geometries
- ▲ No displacement of the insert during machining
- ▲ Reduction of vibration in the machining process
- ▲ Reduction in the number of insert breakages means greater process reliability, longer tool life and reduced costs resulting from tool breakage



The correct clamping procedure

- 1** Manual alignment of the insert and the top-down clamp: the indexing bulge of the clamp engages in one of indexing grooves of the button insert.



Indexing bulge











Indexing grooves





- 2** Positioning of the insert through easy pre-clamping with the clamping claw
- 3** Strong tightening of the lever with the lever screw
- 4** Final fastening by strongly tightening the top-down clamping claw





INSERTS

BUTTON INSERTS RCMT.. / RCMX..

<p>-M23</p> <p>▲ Soft cutting geometry with excellent chip control for small depths of cut in finishing operations</p>		Machining conditions		
				
		CTCP115	CTCP125	CTCP125

<p>-R33</p> <p>▲ Soft cutting geometry for machining various wheels in continuous and slightly interrupted cut</p>		Machining conditions		
				
		CTCP115	CTCP125	CTCP125





<p>-R23</p> <p>▲ For high surface quality in machining operations with continuous cut</p>		Machining conditions		
				
		CTCP115	CTCP125	CTCP125



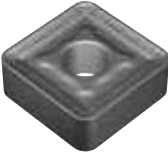

<p>-R53</p> <p>▲ Soft cutting geometry with a very positive rake angle in combination with a stable land</p> <p>▲ For medium turning</p>		Machining conditions		
				
		CTCP115	CTCP125	CTCP125



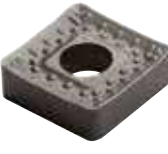

<p>-R83</p> <p>▲ Geometry for high feed rates and large depth of cut as well as varying forging allowance</p> <p>▲ For a very good chip control</p>		Machining conditions		
				
		CTCP115	CTCP125	CTCP125
		CTCP115	CTCP125	CTCP125
		CTCP115	CTCP125	CTCP125



INSERTS

90° INSERTS SNMM..

<p>-R28</p> <ul style="list-style-type: none"> ▲ Single-sided roughing geometry ▲ Longitudinal and face turning, profiling ▲ Inconsistent cutting depth ▲ For steels with high strength (800 N/mm²) ▲ Good chip control 		Machining conditions		
				
		CTCP115	CTCP125	CTCP125
		CTCP115	CTCP125	CTCP125
		CTCP115	CTCP125	CTCP125

<p>-R58</p> <ul style="list-style-type: none"> ▲ Single-sided roughing geometry ▲ Longitudinal and face turning ▲ Slightly interrupted cut ▲ Low cutting forces ▲ Unstable machines 		Machining conditions		
				
		CTCP115	CTCP125	CTCP125
		CTCP115	CTCP125	CTCP125
		CTCP115	CTCP125	CTCP125



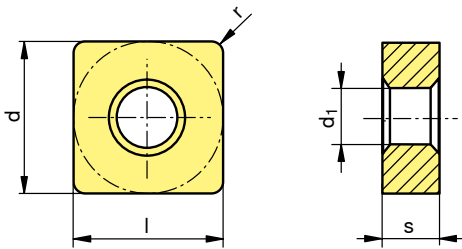

<p>-R88</p> <ul style="list-style-type: none"> ▲ Single-sided roughing geometry ▲ Longitudinal and face turning ▲ High feed rates ▲ Large depths of cut ▲ Heavily interrupted cut 		Machining conditions		
				
		CTCP115	CTCP125	CTCP125
		CTCP115	CTCP125	CTCP125
		CTCP115	CTCP125	CTCP125





			CTCP115		CTCP125		d	l	s	r	d ₁
			●	○	●	○					
-R28		SNMM 190616EN-R28	●	○	●	○	19,05	19,05	6,35	1,60	7,94
		SNMM 250924EN-R28	●	○	●	○	25,40	25,40	9,52	2,40	9,12
-R58		SNMM 190612EN-R58	●	○	●	○	19,05	19,05	6,35	1,20	7,94
		SNMM 190616EN-R58	●	○	●	○	19,05	19,05	6,35	1,60	7,94
		SNMM 190624EN-R58	●	○	●	○	19,05	19,05	6,35	2,40	7,94
		SNMM 250724EN-R58	●	○	●	○	25,40	25,40	7,94	2,40	9,12
		SNMM 250924EN-R58	●	○	●	○	25,40	25,40	9,52	2,40	9,12
-R88		SNMM 190616SN-R88	●	○	●	○	19,05	19,05	6,35	1,60	7,94
		SNMM 190624SN-R88	●	○	●	○	19,05	19,05	6,35	2,40	7,94
		SNMM 250724SN-R88	●	○	●	○	25,40	25,40	7,94	2,40	9,12
		SNMM 250732SN-R88	●	○	●	○	25,40	25,40	7,94	3,20	9,12
		SNMM 250924SN-R88	●	○	●	○	25,40	25,40	9,52	2,40	9,12
		SNMM 250932SN-R88	●	○	●	○	25,40	25,40	9,52	3,20	9,12









INSERTS

80° INSERTS CNMM..

<p>-R28</p> <ul style="list-style-type: none"> ▲ Single-sided roughing geometry ▲ Longitudinal and face turning, profiling ▲ Inconsistent cutting depth ▲ For steels with high strength (800 N/mm²) ▲ Good chip control 		Machining conditions		
				
		CTCP115	CTCP125	CTCP135

<p>-R58</p> <ul style="list-style-type: none"> ▲ Single-sided roughing geometry ▲ Longitudinal and face turning ▲ Slightly interrupted cut ▲ Low cutting forces ▲ Unstable machines 		Machining conditions		
				
		CTCP115	CTCP125	CTCP135

<p>-R88</p> <ul style="list-style-type: none"> ▲ Single-sided roughing geometry ▲ Longitudinal and face turning ▲ High feed rates ▲ Large depths of cut ▲ Heavily interrupted cut 		Machining conditions		
				
		CTCP115	CTCP125	CTCP125

	P	M	K	N	S	H											d [mm]	l [mm]	s [mm]	r [mm]	d ₁ [mm]						
							CTCP115	CTCP125	CTCP135																		
-R28		CNMM 190612EN-R28		●	●	●															19,05	19,30	6,35	1,20	7,94		
		CNMM 190616EN-R28		●	●	●																19,05	19,30	6,35	1,60	7,94	
		CNMM 190624EN-R28		●	●	●																	19,05	19,30	6,35	2,40	7,94
-R58		CNMM 190612EN-R58		●	●	●															19,05	19,30	6,35	1,20	7,94		
		CNMM 190616EN-R58		●	●	●																19,05	19,30	6,35	1,60	7,94	
		CNMM 190624EN-R58		●	●	●																	19,05	19,30	6,35	2,40	7,94
		CNMM 250924EN-R58		●	●	●																	25,40	25,80	9,52	2,40	9,12
-R88		CNMM 190616SN-R88		●	●	●															19,05	19,30	6,35	1,60	7,94		
		CNMM 190624SN-R88		●	●	●																19,05	19,30	6,35	2,40	7,94	
		CNMM 190624SN-R88Q		●	●	●																	19,05	19,30	6,35	2,40	7,94
		CNMM 250924SN-R88		●	●	●																	25,40	25,80	9,52	2,40	9,12

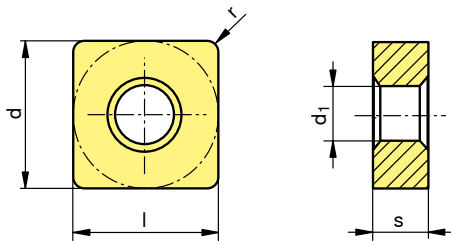



AXLE PRODUCTION

Axle production

The demands on tools and cutting materials in the production of wheel set axles for the railway vehicle industry are extreme. Maximum surface quality and the highest possible degree of process reliability must be guaranteed, in order to meet the mandatory standards.



AXLE PRODUCTION

OVERVIEW

Requirements



Requirements

43

Materials



Materials

44



Cutting material grades

45

Machining examples

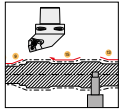

The process

46



Machining the axle ends

47



Roughing the axle

48



Finishing the axle

49

Tooling systems



CERATIZIT standard tools

50–51

Inserts



80° inserts

52–53



55° inserts

54–55



Button inserts

56–57

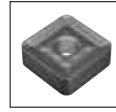

90° inserts

58–59



60° inserts

60–61

Requirements for axle production

In railway vehicles, the axle connects the two wheel disks rigidly with one another. In daily operation it is subjected to extreme stresses (deflection, torsion) and loads (weight). So in the manufacturing of wheel set axles extremely high standards of quality and safety need to be met. Construction, design, production and quality assurance are all regulated by various standards.

For the machining of the steel forgings, top-quality tools and cutting materials are required. These must offer maximum process reliability along with economy. With CERATIZIT's tooling systems, you have an experienced and reliable partner for axle production.

For the production of axles, CERATIZIT offers an extensive range of standard inserts in different geometries and cutting material grades.

The most commonly used solutions for axle production may be found in this brochure. An overview of the entire programme of CERATIZIT machining tools and cutting material grades is given by the current CUTTING TOOLS complete range.

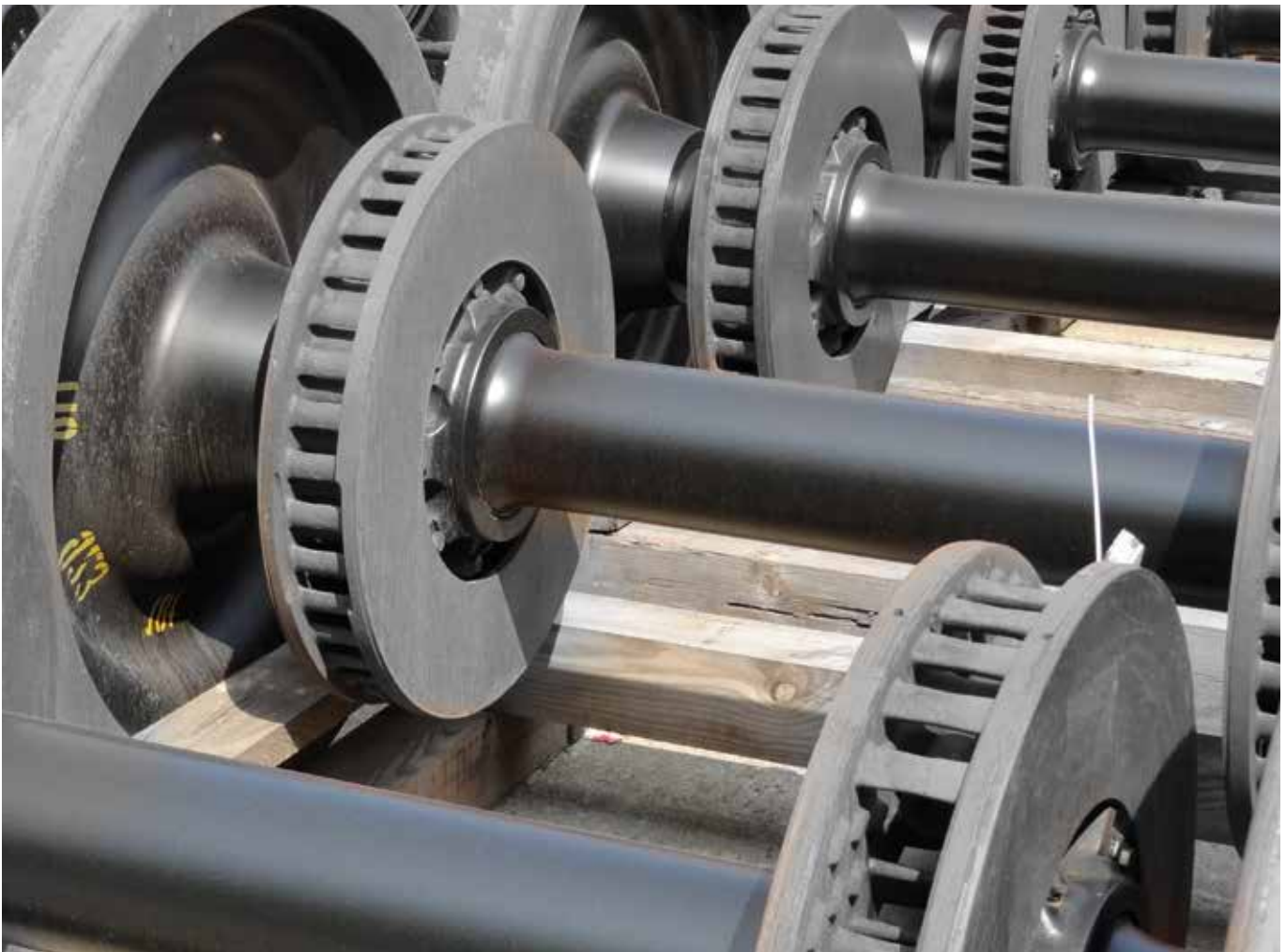

Materials for axle production

Axles are made from special tempered steels, the grades being classified from A1 to A5. For details of the chemical composition and mechanical properties, please see the table below.

Material designation	Chemical composition [%]											As delivered Heat treatment	Mechanical characteristics	
	C	Si	Mn	P	S	Cr	Cu	Mo	Ni	V	(Cr+Mo+Ni)		Tensile strength R_m [N/mm ²]	Brinell hardness [HB]
A1/EA1T	0,42	0,40	0,70	0,045	0,045	0,40	–	0,10	0,40	–	0,63	T N	550 550–700	163–208
A2	0,22	0,40	1,20	0,025	0,030	0,45	0,25	0,15	0,15	0,10	–	N	510–620	152–184
A3	0,50	0,40	0,70	0,045	0,045	0,40	0,10	0,10	0,40	–	0,63	T N	620–770 600–750	184–228
A4/EA4T	0,25	0,25	0,80	0,020	0,015	0,12	–	0,20	0,30	–	–	T	650–800	193–238
A5	0,25	0,25	0,70	0,020	0,015	1,00	–	0,20	0,30	–	–	T	730–880	216–261

N = tempered
T = heat-treated

DIN material designation

Material designation	Standard designation (DIN)
A1 / EA1T	C35
A2	22MnCrV5
A3	C45
A4 / EA4T	25CrMo4
A5	42CrMo4

Cutting material grades for axle production

Three CERATIZIT carbide grades cover the entire spectrum of axle production. From process security for forged surfaces using CTCP135 to high wear resistance in the finishing and reworking process using CTCP115, they deliver the ultimate in performance for a whole range of applications.

The advantages at a glance:

- ▲ Extreme thermal resistance
- ▲ Great toughness
- ▲ Excellent notching resistance
- ▲ High-performance CVD layer (maximum hardness, extremely smooth surface)

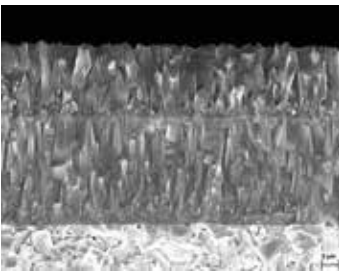
CTCP115 BLACKSTAR™	HC-P15 HC-K25 HC-M10	
	<p>Specification: Composition: Co 5.8%; mixed carbides 6.4%; WC balance Grain size: 1 - 2 μm Hardness: HV₃₀ 1550 Coating specification: CVD TiCN-Al₂O₃</p> <p>Recommended application: The wear-resistant high-performance grade for steel machining.</p>	

CTCP 115 – high hardness – ideal for:

- ▲ Slightly interrupted cut
- ▲ Materials with higher strength
- ▲ Higher cutting parameters

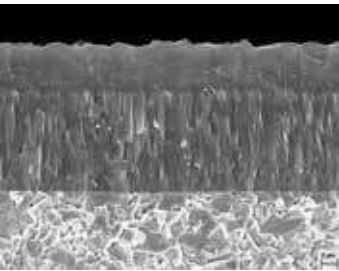
CTCP125 BLACKSTAR™	HC-P25 HC-K30 HC-M20	
	<p>Specification: Composition: Co 7.0%; mixed carbides 8.0%; WC balance Grain size: 1 - 2 μm Hardness: HV₃₀ 1450 Coating specification: CVD TiCN-Al₂O₃</p> <p>Recommended application: The first choice for the universal machining of steel.</p>	

CTCP 125 – high toughness – ideal for:

- ▲ Inconsistent cutting depth
- ▲ Skin on castings or forgings
- ▲ Heavily interrupted cut
- ▲ Materials with medium tensile strength

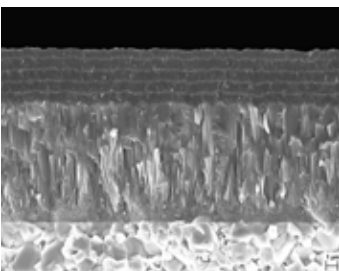
CTCP135 COLORSTAR™	HC-P35 HC-M25 HC-S25	
	<p>Specification: Composition: Co 9.6%; mixed carbides 6.7%; WC balance Grain size: 1 - 2 μm Hardness: HV₃₀ 1460 Coating specification: CVD TiCN-Al₂O₃ multi-layer</p> <p>Recommended application: The tough alternative for heavily interrupted cutting action.</p>	

CTCP 135 – high toughness – ideal for:

- ▲ Heavily interrupted cut
- ▲ Widely varying cutting depth

Axle production – the process

Axle production requires several steps. First the forged blank undergoes face milling at both rod ends, the axle journal is machined on both sides and various holes are bored on the face. The axle is then roughed to size on a turning machine in

line with customer requirements. This removes any residual forging and casting skin. Fine machining of the wheelset profile then takes place using a finishing process.

Machining of the axle ends

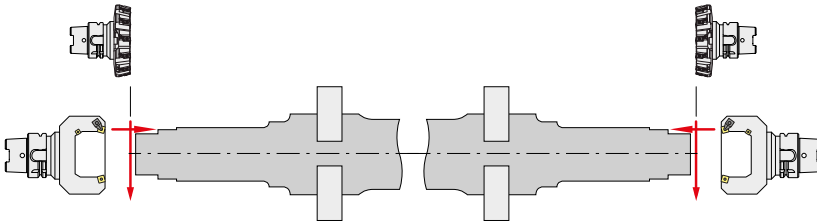

Machining steps

- ▲ Face milling of the rod ends on both sides
- ▲ Milling of the axle end on both sides

Recommended inserts

- ▲ LNUJ 220920SR
- ▲ SNMM 120612SN-R88
- ▲ SNMG 120408EN-M50

Roughing

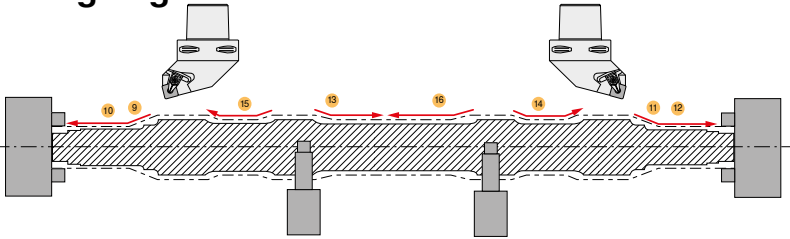

Machining steps

- ▲ Roughing of the wheel set shaft
- ▲ Roughing of the profile

Recommended inserts

- ▲ CNMM -R58, -R88
- ▲ DNMG -R58
- ▲ SNMM -R58, -R88

Finishing

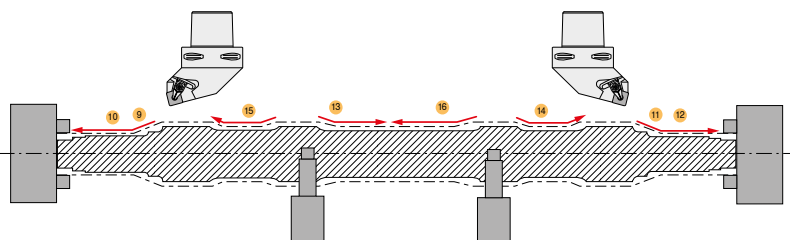

Machining steps

- ▲ Finishing of the wheel set shaft
- ▲ Finishing of the profile

Recommended inserts

- ▲ CNMG -M70, CNMM -R28
- ▲ DNMG -M70, -TMQ, DNMM -R28
- ▲ SNMG -M70, SNMM -R28
- ▲ TNMG -M70, TNMM -R28
- ▲ RCMT -SM, -M23

Machining the axle ends

In preparation for a precise and secure clamping of the axle with a view to rough machining on the lathe, as a first step both axle ends are face milled and both axle ends are milled with precise reference to the form and the position. This task is

accomplished by the use of CERATIZIT standard milling tools and special milling tools created for the specific application case.



Work piece	railway axle – face milling
Material	EA4T / 25CrMo4
Machine	lathe
Tool	MaxiMill AHDM.160.R.08-75-22
Insert	LNUJ 220920SR

Work piece	railway axle – milling of the axle ends
Material	EA4T / 25CrMo4
Machine	lathe
Tool	special combination tool
Insert	SNMM 190612SN-R88



AHDM.160.R.08-75-22



LNUJ 220920SR



GW-DSKNR-2-19-D125

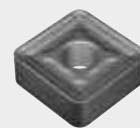

SNMM 190612SN-R88

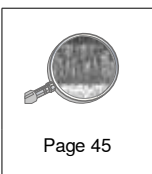

THE BASIS FOR MAXIMUM
EFFICIENCY

Roughing the axle

Rough machining on the lathe gives the railway axle its basic profile. Here what is called for is a high degree of process reliability, with considerable and varying depth of cut and

high feed rates. The following machining example, with the CERATIZIT -R88 insert, supplies customer reference values for this first part of axle production.



Work piece	railway axle
Material	EA4T / 25CrMo4
Machine	lathe
Tool	SSBNR 4040 T25
Insert	SNMM 250924SN-R88

Grade	CTCP125
V_c [m/min]	160
f [mm/rev]	0.5
a_p [mm]	3–6
Coolant	emulsion



SSBNR 4040 T25

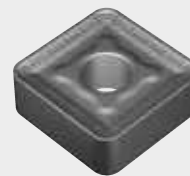

SNMM 250924SN-R88

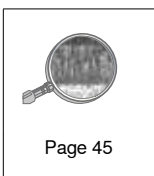

HIGH PROCESS RELIABILITY THANKS TO STABLE
PROTECTIVE CHAMFER



Finishing the axle

When finishing the wheel set shaft, the highest degree of surface quality and process reliability is essential. Even the smallest notches can make a critical difference to functionality.

For perfect finishing, the -M70 insert in cutting material grade CTCP115 is ideal. The table below shows established customer reference values.



Work piece	railway axle
Material	EA4T / 25CrMo4
Machine	lathe
Tool	PSBNL 3232 P15-T
Insert	SNMG 150612EN-M70

Grade	CTCP115
V_c [m/min]	220
f [mm/rev]	0.4
a_p [mm]	1
Coolant	emulsion



PSBNL 3232 P15-T

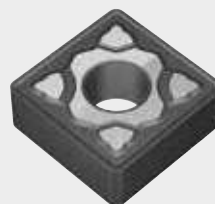

SNMG 150612EN-M70



HIGH SURFACE QUALITY THANKS TO
OPTIMISED **CHIP GROOVE**



CERATIZIT standard tools

CERATIZIT offers an extensive range of tools and inserts for axle production, in various geometries and cutting material grades. The most commonly used inserts are listed on the

following pages of his brochure. Other tools and geometries may be found in our main catalogue.

Special tool holders

Special tool holders can be manufactured on request.

If you are interested in finding out more about CERATIZIT's tools for axle production, please send your enquiry to: info.austria@ceratizit.com.



CERATIZIT CUTTING TOOLS complete range





Most tools for axle production are standard tools. With our wide product assortment of turning tools and inserts, you can be sure of having the best equipment for the task in hand.





Detailed information about our standard turning tools and inserts may be found in the CUTTING TOOLS complete range catalogue. Here is the link to download the file: www.ceratizit.com/en/service/downloads/







INSERTS

80° INSERTS CNMG.. / CNMM..





-TMQ <ul style="list-style-type: none"> ▲ Masterfinish geometry ▲ Light to medium roughing ▲ Very high feed rates ▲ High surface quality 		Machining conditions		
				
		CTCP115	CTCP125	CTCP135

-M70 <ul style="list-style-type: none"> ▲ Light to medium roughing ▲ Skin on castings or forgings ▲ Stable cutting edge ▲ Interrupted cut ▲ For blanks and forged parts 		Machining conditions		
				
		CTCP115	CTCP125	CTCP135

-R28 <ul style="list-style-type: none"> ▲ Single-sided roughing geometry ▲ Longitudinal and face turning, profiling ▲ Inconsistent cutting depth ▲ For steels with high strength (800 N/mm²) ▲ Good chip control 		Machining conditions		
				
		CTCP115	CTCP125	CTCP135

-R58 <ul style="list-style-type: none"> ▲ Single-sided roughing geometry ▲ Longitudinal and face turning ▲ Slightly interrupted cut ▲ Low cutting forces ▲ Unstable machines 		Machining conditions		
				
		CTCP115	CTCP125	CTCP135



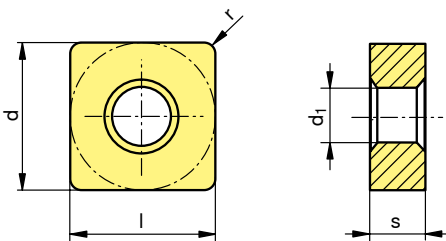

-R88 <ul style="list-style-type: none"> ▲ Single-sided roughing geometry ▲ Longitudinal and face turning ▲ High feed rates ▲ Large depths of cut ▲ Heavily interrupted cut 		Machining conditions		
				
		CTCP115	CTCP125	CTCP125





			CTCP115			CTCP125			CTCP135			d	l	s	r	d ₁	
			P	M	K	N	S	H	P	M	K						N
-TMQ		CNMG 120408EN-TMQ	●	●	●												12,70
		CNMG 120412EN-TMQ	●	●	●												
-M70		CNMG 120408EN-M70	●	●	●												12,70
		CNMG 120412EN-M70	●	●	●												12,70
		CNMG 120416EN-M70	●	●	●												12,70
		CNMG 160608EN-M70	●	●	●												15,88
		CNMG 160612EN-M70	●	●	●												15,88
		CNMG 160616EN-M70	●	●	●												15,88
		CNMG 190612EN-M70	●	●	●												19,05
		CNMG 190616EN-M70	●	●	●												19,05
		CNMG 190624EN-M70	●	●	●												19,05
-R28		CNMM 120408EN-R28	●	●	●												12,70
		CNMM 120412EN-R28	●	●	●												12,70
		CNMM 120416EN-R28	●	●	●												12,70
		CNMM 160612EN-R28	●	●	●												15,88
		CNMM 160616EN-R28	●	●	●												15,88
		CNMM 190612EN-R28	●	●	●												19,05
		CNMM 190616EN-R28	●	●	●												19,05
		CNMM 190624EN-R28	●	●	●												19,05
		CNMM 250924EN-R28	●	●	●												25,40
-R58		CNMM 120408EN-R58	●	●	●												12,70
		CNMM 120412EN-R58	●	●	●												12,70
		CNMM 120416EN-R58	●	●	●												12,70
		CNMM 160612EN-R58	●	●	●												15,88
		CNMM 160616EN-R58	●	●	●												15,88
		CNMM 190612EN-R58	●	●	●												19,05
		CNMM 190616EN-R58	●	●	●												19,05
		CNMM 190624EN-R58	●	●	●												19,05
		CNMM 250924EN-R58	●	●	●												25,40
-R88		CNMM 190616SN-R88	●	●	●												19,05
		CNMM 190624SN-R88	●	●	●												19,05
		CNMM 190624SN-R88Q	●	●	●												19,05
		CNMM 250924SN-R88	●	●	●												25,40







INSERTS

55° INSERTS DNMG.. / DNMM..

-TMQ <ul style="list-style-type: none"> ▲ Masterfinish geometry ▲ Light to medium roughing ▲ Very high feed rates ▲ High surface quality 		Machining conditions		
				
		CTCP115	CTCP125	CTCP135

-M70 <ul style="list-style-type: none"> ▲ Light to medium roughing ▲ Skin on castings or forgings ▲ Stable cutting edge ▲ Interrupted cut ▲ For blanks and forged parts 		Machining conditions		
				
		CTCP115	CTCP125	CTCP135

-R28 <ul style="list-style-type: none"> ▲ Single-sided roughing geometry ▲ Longitudinal and face turning, profiling ▲ Inconsistent cutting depth ▲ For steels with high strength (800 N/mm²) ▲ Good chip control 		Machining conditions		
				
		CTCP115	CTCP125	CTCP135





-R58 <ul style="list-style-type: none"> ▲ Single-sided roughing geometry ▲ Longitudinal and face turning ▲ Slightly interrupted cut ▲ Low cutting forces ▲ Unstable machines 		Machining conditions		
				
		CTCP115	CTCP125	CTCP135





	Image	Part Number	CTCP			d	l	s	r	d _i
			115	125	135					
--TMQ		DNMG 150608EN-TMQ	●	●	●	12,70	15,50	6,35	0,80	5,16
		DNMG 150612EN-TMQ	●	●		12,70	15,50	6,35	1,20	5,16
-M70		DNMG 110408EN-M70	●	●	●	9,52	11,60	4,76	0,80	3,81
		DNMG 110412EN-M70				9,52	11,60	4,76	1,20	3,81
		DNMG 150408EN-M70	●	●	●	12,70	15,50	4,76	0,80	5,16
		DNMG 150412EN-M70	●	●	●	12,70	15,50	4,76	1,20	5,16
		DNMG 150416EN-M70	●	●	●	12,70	15,50	4,76	1,60	5,16
		DNMG 150608EN-M70	●	●	●	12,70	15,50	6,35	0,80	5,16
		DNMG 150612EN-M70	●	●	●	12,70	15,50	6,35	1,20	5,16
		DNMG 150616EN-M70	●	●	●	12,70	15,50	6,35	1,60	5,16
-R28		DNMM 150612EN-R28	●	●	●	12,70	15,50	6,35	1,20	5,16
		DNMM 150616EN-R28	●	●	●	12,70	15,50	6,35	1,60	5,16
-R58		DNMM 150612EN-R58	●	●	●	12,70	15,50	6,35	1,20	5,16
		DNMM 150616EN-R58	●	●	●	12,70	15,50	6,35	1,60	5,16



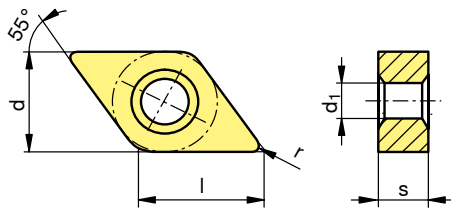



INSERTS

BUTTON INSERTS RCGT..., RCMT..









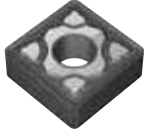

<p>-M23</p> <p>▲ Soft cutting geometry with excellent chip control for small depths of cut in finishing operations</p>		Machining conditions		
				
		CTCP115	CTCP125	CTCP135



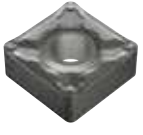

<p>-SM</p> <p>▲ Medium machining ▲ Universal application ▲ Stable cutting edge ▲ Inconsistent cutting depth ▲ Wide range of applications</p>		Machining conditions		
				
		CTCP115	CTCP125	CTCP135



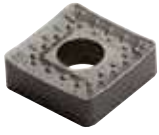

INSERTS

90° INSERTS SNMG.. / SNMM.. / SNMT..

<p>-M70</p> <ul style="list-style-type: none"> ▲ Light to medium roughing ▲ Skin on castings or forgings ▲ Stable cutting edge ▲ Interrupted cut ▲ For blanks and forged parts 		Machining conditions		
				
		CTCP115	CTCP125	CTCP135

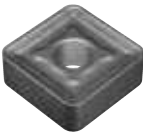



<p>-R28</p> <ul style="list-style-type: none"> ▲ Single-sided roughing geometry ▲ Longitudinal and face turning, profiling ▲ Inconsistent cutting depth ▲ For steels with high strength (800 N/mm²) ▲ Good chip control 		Machining conditions		
				
		CTCP115	CTCP125	CTCP135





<p>-R58</p> <ul style="list-style-type: none"> ▲ Single-sided roughing geometry ▲ Longitudinal and face turning ▲ Slightly interrupted cut ▲ Low cutting forces ▲ Unstable machines 		Machining conditions		
				
		CTCP115	CTCP125	CTCP135





<p>-R88</p> <ul style="list-style-type: none"> ▲ Single-sided roughing geometry ▲ Longitudinal and face turning ▲ High feed rates ▲ Large depths of cut ▲ Heavily interrupted cut 		Machining conditions		
				
		CTCP115	CTCP125	CTCP135

INSERTS

60° INSERTS TNMG.. / TNMM..

-M70 <ul style="list-style-type: none"> ▲ Light to medium-rough machining ▲ Skin on castings or forgings ▲ Stable cutting edge ▲ Interrupted cut ▲ Blanks and forged parts 		Machining conditions		
				
		CTCP115	CTCP125	CTCP135

-R28 <ul style="list-style-type: none"> ▲ Single-sided roughing geometry ▲ Longitudinal and face turning, profiling ▲ Inconsistent cutting depth ▲ For steels with high strength (800 N/mm²) ▲ Good chip control 		Machining conditions		
				
		CTCP115	CTCP125	CTCP135

-R58 <ul style="list-style-type: none"> ▲ Single-sided roughing geometry ▲ Longitudinal and face turning ▲ Slightly interrupted cut ▲ Low cutting forces ▲ Unstable machines 		Machining conditions		
				
		CTCP115	CTCP125	CTCP135

WHEEL REPROFILING



Wheel reprofiling

As a result of the interaction of the wheel and the rail in daily operation, the wheels of railway vehicles are subjected to enormous stress. In order to ensure safe and comfortable travel, the geometries of the wheel profiles need to be regularly checked and reprofiled.



Requirements



Requirements

65

Materials



Materials

66



Cutting material grades

67

Machining examples

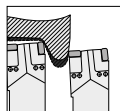

The process

68



Wheel reprofiling

69

Tooling systems



Tool holders, tools upon request,
cartridge systems

70–71



Cartridge system CNMX 19..

72



Cartridge system SNMG 21..

73



Cartridge system LNUX 19../30..

74



Cartridge system LNUX 19..

75

Inserts



80° inserts CNMX..

76–77



90° inserts SNMG..

78–79



90° inserts LNUX..

80–81

Requirements for wheel reprofiling

In view of the long distances and long hours of travel, the wheels of rail vehicles suffer a great deal of wear. Material abrasion and deformation are the result. The stress is particularly great when the brakes are sharply applied, or on curved sections of track. In the case of blocking wheels the material becomes compacted, extremely hard surface areas form, the wheel is no longer round and runs irregularly.

Along with the condition of the rails, the wheel profile is the crucial factor for safety and comfort. In order to guarantee smooth running and low noise, rail wheels need to be reprofiled at regular intervals. The intervals of reprofiling will vary according to the requirements involved. With freight trains it may come to several years; in the case of high speed trains, it may be as often as every few months.

The reprofiling of wheels and wheel sets makes great demands on the cutting tools. The task involves machining changing

materials, under widely varying conditions and at different depths of cut – all of this with perfect process reliability and in the shortest time possible.

The challenge for the tool manufacturer, when it comes to reprofiling the wheels consists in developing tools and inserts that are hard, wear-resistant and at the same time tough enough to achieve the required length of service life when machining the rim, running surface and the hard braking points. CERATIZIT's CTCP115 and CTCP125 grades have all the necessary properties for meeting these high expectations.



Materials in wheel reprofiling

For wheel reprofiling, we find the same tempered steels (R1 to R9) in use as in new wheel production. Their chemical composition and mechanical properties are shown in the table below.

Material designation	Tensile strength R_m [N/mm ²]	Brinell hardness [HB]
R1	600–720	178–214
R2	700–840	208–249
R3	800–940	238–278
R6	780–900	231–266
R7	820–940	242–278
R8	860–980	255–290
R9	900–1050	266–311



Cutting material grades for wheel reprofiling

The CERATIZIT cutting material grade CTCK120 is the all-rounder for extremely hard steel materials. Together with the two CERATIZIT high-performance grades CTCP115 and CTCP125, this covers the entire spectrum of requirements in connection with wheel reprofiling. All three offer extreme wear resistance, as well as meeting the highest standards of process reliability.

The advantages at a glance:

- ▲ Extreme heat resistance
- ▲ High toughness
- ▲ Excellent resistance to notching
- ▲ CVD high-performance coating (extreme hardness, very smooth surface)

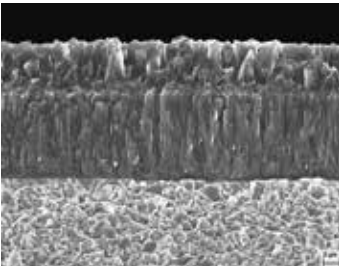
CTCK120 BLACKSTAR™	HC-K20 HC-P10	
	<p>Specification: Composition: Co 6.0%; TaC 2.0%; WC balance Grain size: 1 μm Hardness: HV₃₀ 1630 Coating specification: CVD TiCN-Al₂O₃</p> <p>Recommended application: The first choice for the machining of cast iron at high cutting speeds and where high toughness is required.</p>	

CTCK 120 – high toughness – ideal for:

- ▲ High cutting speed
- ▲ Stable cutting conditions
- ▲ Materials with high strength

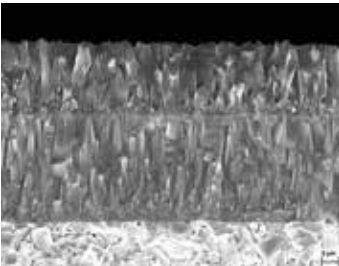
CTCP115 BLACKSTAR™	HC-P15 HC-K25 HC-M10	
	<p>Specification: Composition: Co 5.8%; mixed carbides 6.4%; WC balance Grain size: 1 - 2 μm Hardness: HV₃₀ 1550 Coating specification: CVD TiCN-Al₂O₃</p> <p>Recommended application: The wear-resistant high-performance grade for steel machining.</p>	

CTCP 115 – high hardness – ideal for:

- ▲ Slightly interrupted cut
- ▲ Materials with higher strength
- ▲ Higher cutting parameters

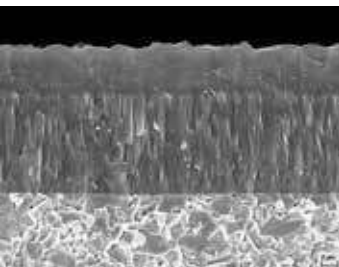
CTCP125 BLACKSTAR™	HC-P25 HC-K30 HC-M20	
	<p>Specification: Composition: Co 7.0%; mixed carbides 8.0%; WC balance Grain size: 1 - 2 μm Hardness: HV₃₀ 1450 Coating specification: CVD TiCN-Al₂O₃</p> <p>Recommended application: The first choice for the universal machining of steel.</p>	

CTCP 125 – high toughness – ideal for:

- ▲ Inconsistent cutting depth
- ▲ Skin on castings or forgings
- ▲ Heavily interrupted cut
- ▲ Materials with medium strength

Wheel reprofiling – the process

Wheel reprofiling is a dry machining operation. It comes in two variants. First there is underfloor machining – here the wheel set lathe is located beneath the train or wagon in a work pit. The wheels can be machined without being taken off the vehicle.

Then there is overfloor machining – here the wheel sets are removed. This is very much more laborious, but speeds up the machining time by half.

Reprofiling of the wheel flange and running surface

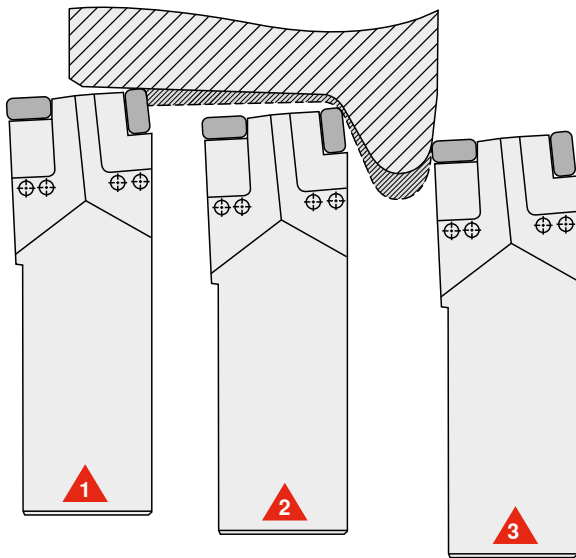

Requirements

- 1 Outer insert: LNUX 191940SN-R70 – the extremely hard surface and flat areas are frequently problematic
- 2 Outer insert: LNUX 191940SN-R70 – difficulties result on the one hand from the tight approach angle, and on the other from the long chips that are produced
- 3 Inner insert: LNUX 191940SN-R70 – when machining the inner side, the challenge lies in the need to ensure the long service life of the insert.

Recommended inserts:

- ▲ CNMX 19..
- ▲ SNMG 21..
- ▲ LNUX 19..
- ▲ LNUX 30..



Wheel reprofiling with LNUX 301940SN-R70

The reliable roughing and finishing of the wheel flange and running surface is a challenge for the maintenance of rail vehicle wheels. As a result of flat areas and cracks, the mate-

rial hardness can vary, which makes the machining very much more difficult. The following customer reference values provide benchmarks for the reprofiling of wheels.



Work piece	wheel set
Material	R7
Machine	portal lathe for wheel sets
Tool	RKH 6060-R / L
Insert	LNUX 301940SN-R70

Grade	CTCP125
V_c [m/min]	75
f [mm/rev]	0.7
a_p [mm]	5–10
Coolant	dry

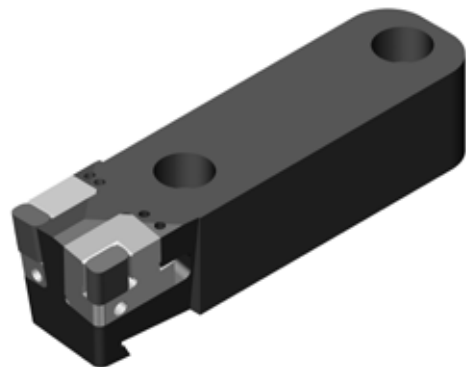

RKH 6060-R / L



LNUX 301940SN-R70



REDUCED CUTTING FORCES
THANKS TO OPTIMISED GEOMETRY
////////////////////

Tools upon request

All tools for wheel reprofiling can be manufactured upon request.

If you are interested in CERATIZIT's tools for wheel reprofiling, please send your enquiry to:
info.austria@ceratizit.com

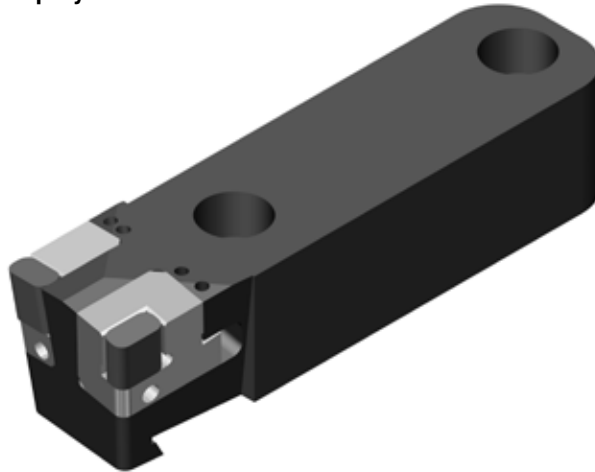

CERATIZIT cartridge systems

Use of CERATIZIT cartridge systems can extend the service life of your tool holders significantly. If the insert pocket is worn or damaged, you don't need to change the complete holder, you can just replace the cartridge. This offers our customers extended tool life in combination with reduced costs. Our cartridge systems for wheel reprofiling are available for various different inserts. Most of them are available from the standard product range.

Easy cartridge change

- 1** Disassemble the worn or broken cartridge system
- 2** Insert a new cartridge system and fix it in place
- 3** Mount a new insert and fix the lever lock clamping screw in place

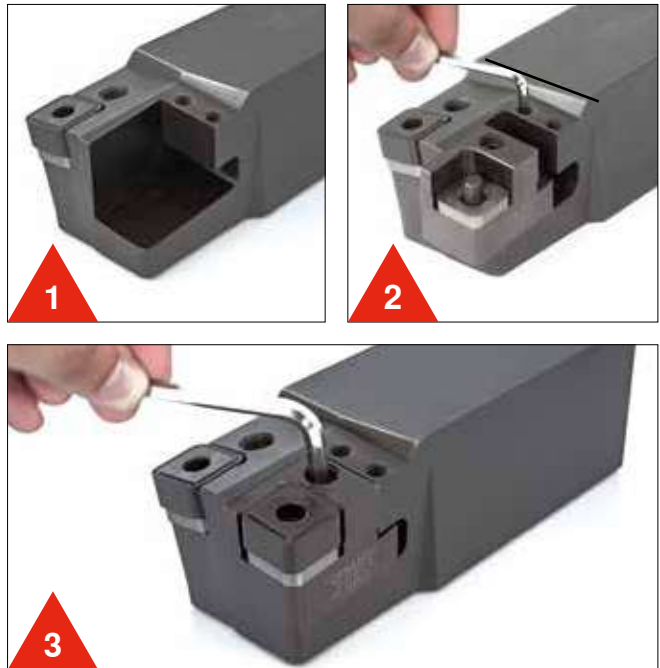

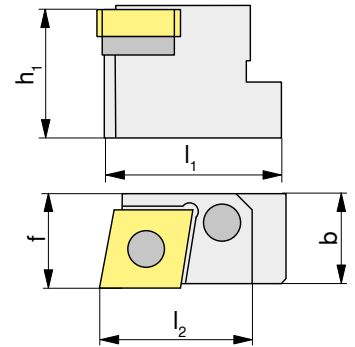

TOOLING SYSTEMS

CARTRIDGE SYSTEM CNMX 19..



Picture shows right-hand version

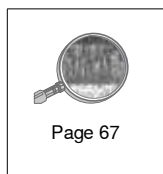

h_1 [mm]	Type, designation	L N R 	l_1 [mm]	l_2 [mm]	b [mm]	f [mm]		
31,00	RK 3219-C19R	R	42,70	36,50	17,90	19,00	CNMX 19..	E01
31,00	RK 3219-C19L	L	42,70	36,50	17,90	19,00	CNMX 19..	E01
31,00	RK 3223-C19R	R	42,70	36,50	21,90	23,00	CNMX 19..	E01
31,00	RK 3223-C19L	L	42,70	36,50	21,90	23,00	CNMX 19..	E01

							
E01	59448	357187		59439	59434	86178	4209

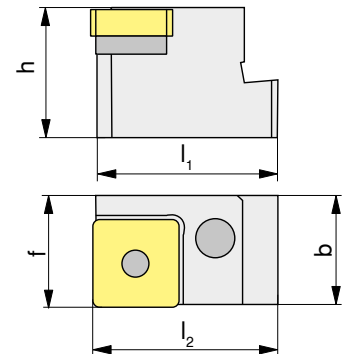



Picture shows right-hand version

h_1 [mm]	Type, designation	L N R 	l_1 [mm]	l_2 [mm]	b [mm]	f [mm]		
32,00	RK 3226-21R	R	43,00	35,00	24,80	26,00	SNMG 21..	E03
32,00	RK 3226-21L	L	43,00	35,00	24,80	26,00	SNMG 21..	E03

							
E03	59448		308268	59439	59434	86178	4209

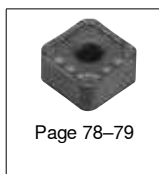
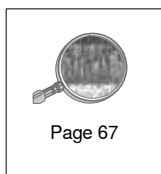

TOOLING SYSTEMS

CARTRIDGE SYSTEM LNUX19../30..

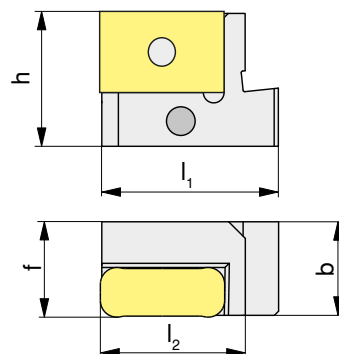

Picture shows right-hand version

h ₁ [mm]	Type, designation	LNR 	l ₁ [mm]	l ₂ [mm]	b [mm]	f [mm]		
32,00	RK 3223-19R	R	43,00	35,00	22,50	23,00	LNUX 19..	E02
32,00	RK 3223-19L	L	43,00	35,00	22,50	23,00	LNUX 19..	E02
32,00	RK 3223-30R	R	43,00	35,00	22,50	23,00	LNUX 30..	E02
32,00	RK 3223-30L	L	43,00	35,00	22,50	23,00	LNUX 30..	E02

E02	59441				59433		4771

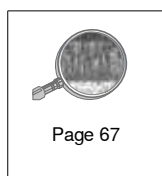

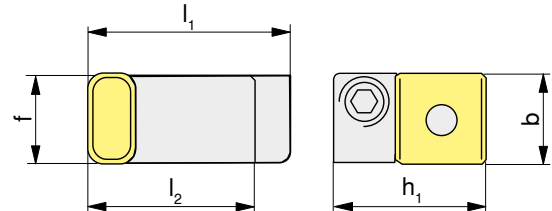

Picture shows right-hand version

h_1 [mm]	Type, designation	L N R 	l_1 [mm]	l_2 [mm]	b [mm]	f [mm]		
32,00	RK 3219-19R	R	43,00	35,00	18,60	19	LNUX 19..	E02
32,00	RK 3219-19L	L	43,00	35,00	18,60	19	LNUX 19..	E02



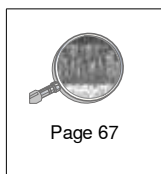

E02	59441				59433		4771



INSERTS

80°insert CNMX 19..









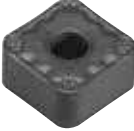

<p>CNMX19.. -SN</p> <ul style="list-style-type: none"> ▲ Special geometry for wheel reprofiling ▲ For excellent chip control 		Machining conditions			
					
		CTCK120	CTCP115		

INSERTS

90° INSERTS SNMG 21..







<p>SNMG 21.. -R70</p> <ul style="list-style-type: none"> ▲ Roughing geometry for wheel reprofiling ▲ Stable geometry for long tool life ▲ For excellent chip control 		Machining conditions		
				
		CTCP115	CTCP125	CTCP125





<p>SNMG 21.. -R71</p> <ul style="list-style-type: none"> ▲ Finishing geometry for wheel set machining ▲ Very soft cutting action for excellent surface quality ▲ Special chip groove for good chip control ▲ Short chipping at low feed rates 		Machining conditions		
				
		CTCP115	CTCP125	CTCP125





INSERTS





90° INSERTS LNUX 19.. / LNUX 30..



<p>LNUX 19.. -R70</p> <ul style="list-style-type: none"> ▲ Roughing geometry for wheel reprofiling ▲ Stable geometry for long tool life ▲ Very stable cutting edge for difficult cutting conditions ▲ For excellent chip control 		Machining conditions		
				
		CTCP115	CTCP125	CTCP125

<p>LNUX 30.. -R70</p> <ul style="list-style-type: none"> ▲ Roughing geometry for wheel reprofiling ▲ Stable geometry for long tool life ▲ Very stable cutting edge for difficult cutting conditions ▲ For excellent chip control 		Machining conditions		
				
		CTCP115	CTCP125	CTCP125

<p>LNUX 19.. -R74</p> <ul style="list-style-type: none"> ▲ Universal geometry for wheel set machining ▲ For soft cut, short chipping 		Machining conditions		
				
		CTCP115	CTCP125	CTCP125

<p>LNUX 30.. -R74</p> <ul style="list-style-type: none"> ▲ Universal geometry for wheel reprofiling ▲ For soft cut, short chipping 		Machining conditions		
				
		CTCP115	CTCP125	CTCP125



Bogie machining

In daily operation, the bogies of railway vehicles are subject to extreme stresses of many different kinds. This places equally high demands on their production, with the aim of ensuring safety and comfort when travelling by rail.



Requirements



Requirements

85

The process

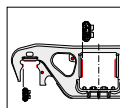

The process

86

Tools



Drills

87



Milling cutters – face milling

88



Milling cutters – shoulder and slot milling

89



Requirements for bogie machining

The undercarriages of railway vehicles consist of a cast or welded (in rarer cases riveted) frame placed over the axle box, to which the wheel sets, springs and dampers are attached. The task of the undercarriages or bogies is to keep the train moving safely and comfortably on the tracks. To do this they must transmit the forces that are generated, so they are permanently exposed to a variety of extremely high pressures.

Undercarriages come in a great many different variants: for locomotives, passenger train carriages and goods train wagons, with primary or secondary springs, with or without a cradle and with different kinds of dampers. The challenge in the machining of these components that are crucial to the railway industry lies in the wide variety of the parts and

materials involved. For the machining of the undercarriage, accurate cutting tools with maximum economy are called for. High-performance cutting materials and ultra-precise tools for drilling and milling from CERATIZIT's standard range meet these requirements perfectly. They offer a maximum of process reliability along with the short machining times that are needed. With CERATIZIT, our customers in the railway vehicle industry have an experienced and reliable partner they can count on.

CERATIZIT complete range

Many of the milling and drilling tools used for bogie machining are standard tools. With our wide product range of robust milling and drilling tools and our extensive assortment of high-performance carbide drills, you can be sure of finding the ideal equipment to meet your needs.

Detailed information about our standard milling and drilling tools may be found in the current CUTTING TOOLS complete range catalogue. You can download it from the following link:

www.ceratizit.com/en/service/downloads/

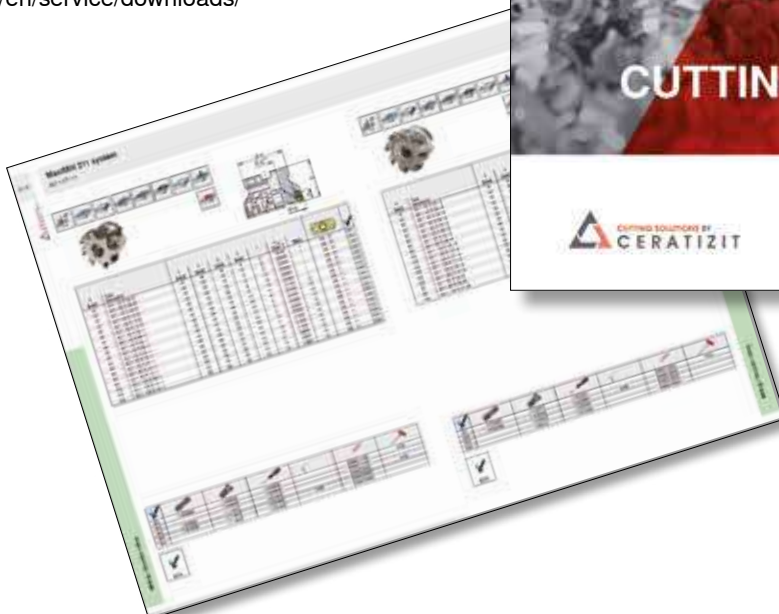

Bogie machining – the process

In view of the varying structure and materials of bogies and undercarriages, their machining involves different cutting techniques. CERATIZIT's tool systems for drilling, face milling, slot milling, and shoulder milling,

slot milling and shoulder milling have proved fully effective in this context, offering the benefits of long tool life along with maximum flexibility.

Bogie machining

Application range

- ▲ Drilling
- ▲ Face milling
- ▲ Slot milling
- ▲ Shoulder milling

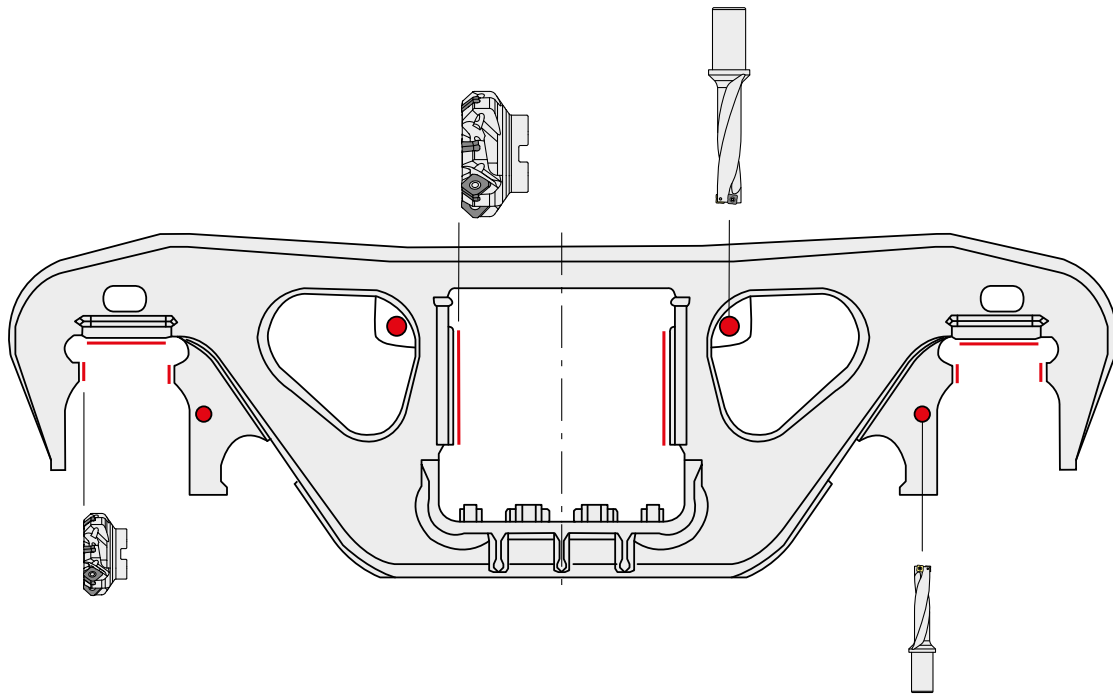

CERATIZIT drills

For bogie machining CERATIZIT offers a wide range of efficacious tools for drilling into solid material. The MaxiDrill 900 in particular, with its top-quality, long-lasting coating and patented insert system, can contribute to improved productivity and greater economy.

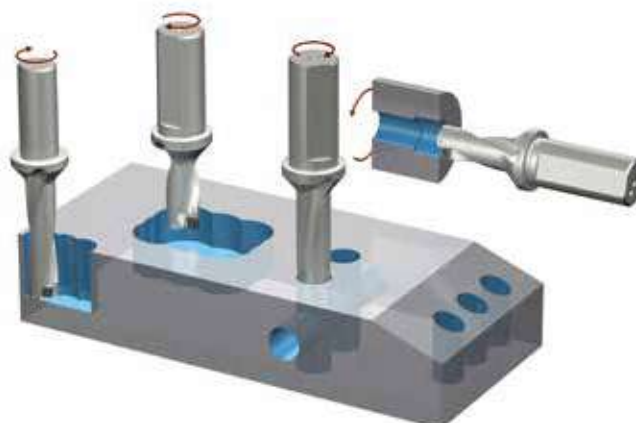

Recommendations for bogie machining

High-performance carbide drills

For bogie machining, CERATIZIT's universally versatile high-performance drills guarantee a very long tool life, narrow manufacturing tolerances, constant performance and stable processes.

CERATIZIT offers its customers in the railway vehicle industry a comprehensive range of carbide drills for universal application and for the machining of steel and cast metals.

Further information may be found on our website www.ceratizit.com

MaxiDrill 900 – our high-performance tool for solid drilling

The MaxiDrill 900 combines superb performance with maximum productivity. Thanks to its stable structure and asymmetrical, innovative design, it offers perfect drilling quality and ideal chip removal even with high cutting values. Its controlled deflection forms the basis for drilling without retraction grooves, and protects surfaces and cutting edges. In combination with CERATIZIT's patented inserts, the MaxiDrill 900 high-performance drill is an economical system solution, and guarantees great precision along with maximum process security and reduced costs.

Product characteristics

- ▲ Easy handling
- ▲ One geometry and one grade for profile and periphery
- ▲ Wide product range



CERATIZIT face milling cutters

CERATIZIT offers a wide range of tools and inserts for face milling. Above all the MaxiMill 271, MaxiMill 273 and MaxiMill HFC high-performance milling cutters are perfectly capable of managing the complex machining tasks in bogie machining and offer the required high process reliability.

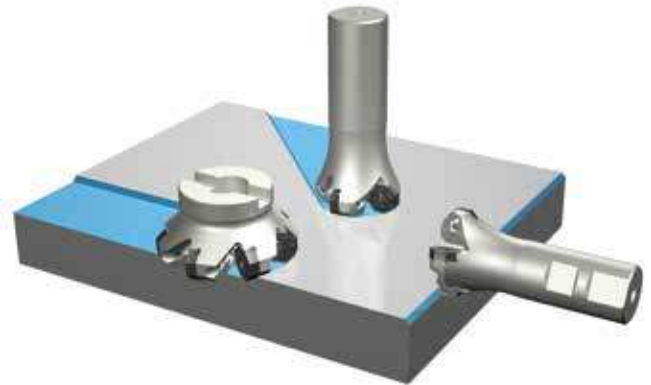

Recommendations for bogie machining

MaxiMill 271 – maximum power

Maximum depths of cut for high productivity

With depths of cut up to 8.4 mm and 8 effective cutting edges per insert, MaxiMill 271 achieves a very good metal removal rate at low cost per edge.

Economic efficiency + process reliability

The stable double-sided insert with positive clearance angle ensures very soft cutting action in virtually all materials. The optimised geometry and open chip pockets provide for best chip evacuation and maximum process reliability.

Application range

- ▲ Face milling
- ▲ Slot milling
- ▲ Chamfering

MaxiMill 273 – 16 times face milling with one insert

Economical for a wide range of materials

16 cutting edges per insert guarantee maximum economy of the machining process. The milling cutter is for universal application and suitable for both roughing and finishing.

Stability and process security combined with low power consumption

The negative position of the insert and the positive clearance angle on two sides ensure stable and secure processes. At the same time MaxiMill 273 is characterised by low vibration and ensures clean work piece surfaces despite its low power consumption.

Application range

- ▲ Face milling
- ▲ Slot milling
- ▲ Chamfering

MaxiMill HFC – the superlative milling cutter

Maximum metal removal rate

MaxiMill HFC achieves maximum cutting performance. The rake angle of the insert is very low so that the cutting forces are in the direction of the spindle. Feed rates up to 3 mm per tooth are therefore possible.

Maximum spindle protection

The light cutting geometry in combination with a compact and stable cutter body construction provides for smooth and vibration-reduced milling action while protecting the spindle.

Application range

- ▲ Face milling with max. fz = 3mm/tooth
- ▲ Helical plunging to produce deep pockets with maximum metal removal rates
- ▲ Angled ramping to produce deep pockets with maximum metal removal rates
- ▲ Slot milling
- ▲ Plunging



CERATIZIT shoulder and slot milling

In view of the numerous different shapes and components which have to be machined, the tools used for slot and shoulder milling must above all be robust, suitable for universal application and flexible. The CERATIZIT MaxiMill 211 and MaxiMill 491 milling cutter meet these requirements perfectly, offering both maximum precision and supreme process reliability.

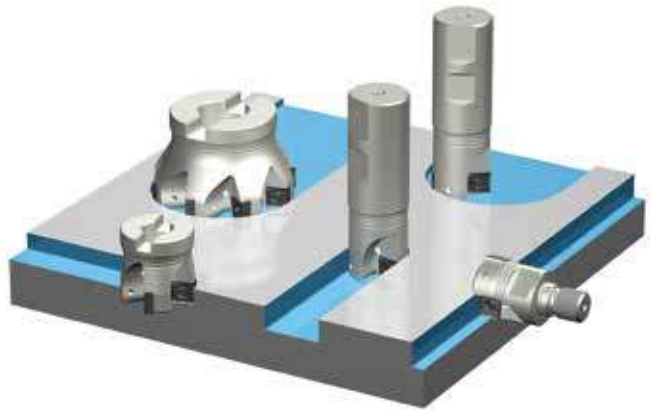

Recommendations for bogie machining

MaxiMill 211 – for roughing and universal application

Precise machining

The 'notch' provides additional stability when plunging (up to r 1.60 mm). Reduced machining noise without vibration is therefore largely guaranteed.

Application range

- ▲ Peripheral milling
- ▲ Shoulder milling
- ▲ Angled ramping & pocket milling
- ▲ Axial & helical plunging
- ▲ Trochoidal slot milling
- ▲ Slot milling
- ▲ Shoulder & face milling

MaxiMill 491 – shoulder milling system with 8 usable cutting edges per insert with exactly 90° approach angle

Best performance and quality

The MaxiMill 491 milling system produces an exact 90° profile with 8 usable cutting edges. The inserts receive a peripheral grinding and achieve very high surface quality together with excellent axial run-out and concentricity. The perfectly adapted chip flute guarantees optimum chip transport, while low power consumption of the spindle ensures reduced vibration during the milling process.

Application range

- ▲ Face milling
- ▲ Shoulder milling
- ▲ Slot milling
- ▲ Trochoidal slot milling
- ▲ Peripheral milling

Further information may be found on our website
www.ceratizit.com





OEM services

We not only offer our partners in the railway industry excellent cutting tools but also customised complete solutions. Every one of our projects is supported and centrally coordinated by a dedicated OEM team. The experts at the CERATIZIT centre of excellence for cutting tool solutions are concerned to meet your individual requirements providing complete process solutions and tool packages for the most varied challenges of wheel set machining. In this way you can count on being given the solution best adapted to your needs.



Customised complete solutions

In collaboration with machine and wheel set manufacturers CERATIZIT offers complete process solutions. We not only supply you with excellent cutting tools, we will also give you the expert support you need when implementing your specific concept on site with CERATIZIT OEM services.

Here is what you can expect:

- ▲ Analysis and optimisation of machining processes
- ▲ Offer of suitable tool packages
- ▲ Time studies
- ▲ Recommendation of cutting data
- ▲ Detailed technical information
- ▲ Support on site

CERATIZIT OEM services

For every project we set up a dedicated team of experts comprising various specialisations. Make use of the fund of knowledge we have amassed at the CERATIZIT cutting tools centre - ranging from application engineering to design, comprising construction, production, sales and logistics.

In this way we are able to guarantee maximum professionalism and reliability as well as solutions that are individually adapted to your needs. Additionally, we will help you to implement your specific concept on site.

Our OEM services include:

- ▲ Definition of machining phases
- ▲ Determination of cutting data and calculation of machining times
- ▲ Calculation of machining costs per piece
- ▲ Projection of tooling costs per piece
- ▲ Calculation of performance (cutting forces, spindle power, torque moment)
- ▲ Tool mounting and presetting
- ▲ Support during final acceptance and commissioning runs
- ▲ Detailed project documentation



A detailed operation plan

First of all CERATIZIT's OEM team draws up a detailed operation plan for the tool. This is where the different working steps are defined and numbered. The suitable tools for the job are allocated directly in optical terms. They can immediately be identified by their designation (e.g. TU001) in subsequent lists and plans. This way you can see at a glance which tool package is going to be used for which working step.

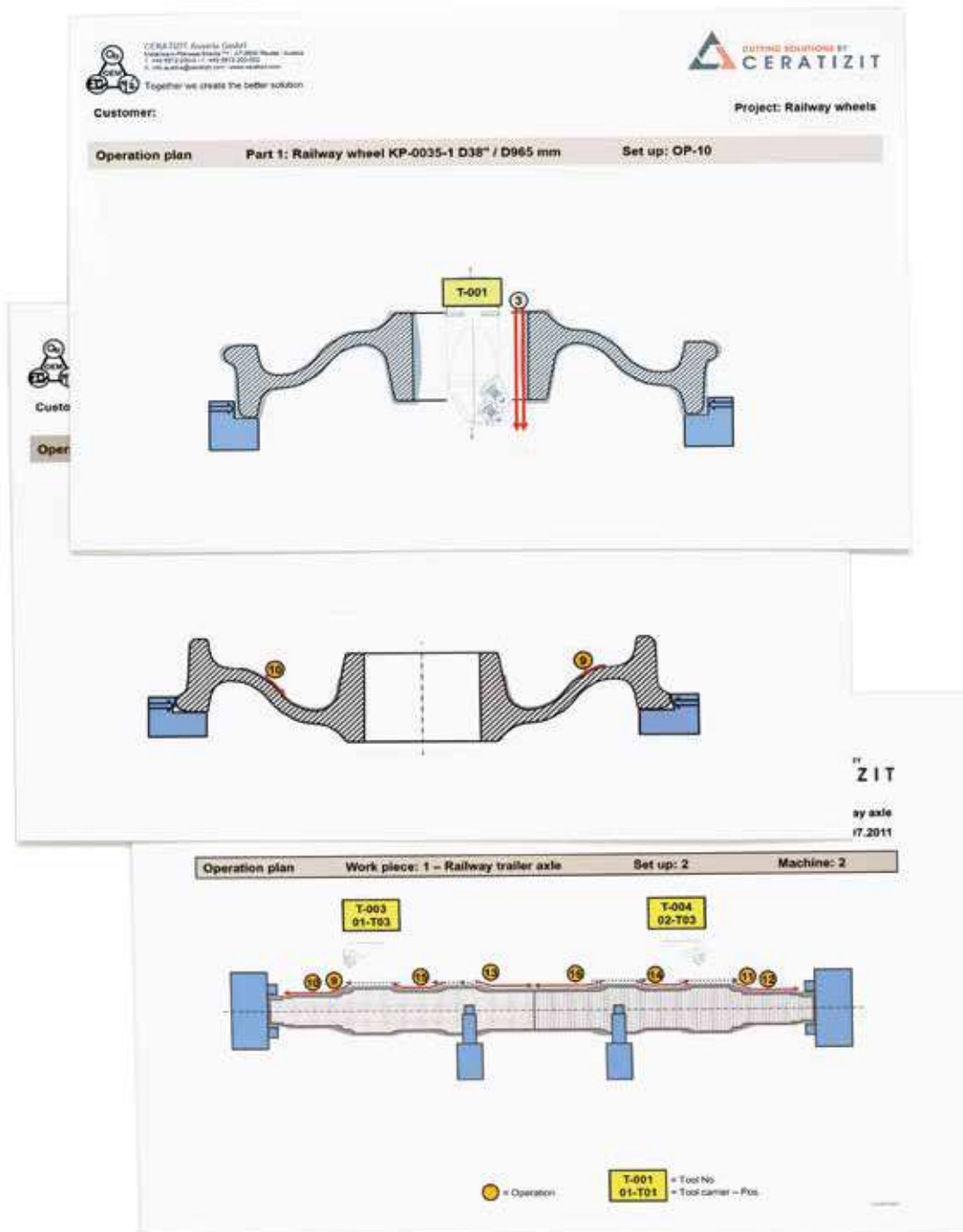

Tooling elements

The tooling element sheets give an overview of all the components used for undercarriage machining, along with the different order numbers. They convey information about the necessary basic equipment of tool systems and inserts, including specifications of the calculated annual requirement and the computed order date.

If you are interested in CERATIZIT's OEM services, please send your enquiry to: info.austria@ceratizit.com









CERATIZIT Deutschland GmbH
D-72186 Emslingen
www.ceratizit.com
Together we create the better solution



Customer: **Project Railway wheels**

Tooling elements				Basic equipment	Complete project		
Pos.	Order number	CERATIZIT-Mat.	Customer-Id-No.	Description	Image	Pieces	Used for tool
1	RCMX 320M05N-R53 CTCPI25	11769402				30	[T-001] [T-002]
2	UT105-DRGCL-32 10016075	11920943		Drehkopf		2	[T-001]
3	BNMM 2507245N-R68 CTCPI25	11562480				20	[T-003]
4	UT100-D5KNR-2-25 10017265	11920954		Ausdrehkopf 2-schneidig		2	[T-003]











CERATIZIT Austria Gesellschaft mb. B. H.
A-6060 Brunnau, Tirol
www.ceratizit.com
Together we create the better solution



Customer **Projekt: Eisenbahnachse**
O-000198 / Datum: TT.MM.JJJJ

von 5

Pos.	Order number	CERATIZIT-Mat.	Customer-Id-No.	Description	Image	Pieces	OEM-Set		Delivery times	
							per piece	Summary	Pieces	Site
10	HSA-763-DCLNR-12	11562392		Cutting head Maxlock D		0	0,00	0,00		TT.MM.JJJJ
11	DM60 1204162N-TMR CTCPI25	11342627		side turning insert		0	0,00	0,00		TT.MM.JJJJ
12	AJ28 DCLNR 12	11224892		Maxlock D internal turning tool		0	0,00	0,00		TT.MM.JJJJ
13	HSA-763-BH102-05	11573888		Boringbar holder		0	0,00	0,00		TT.MM.JJJJ
14	DM60 1204162N-TMR CTCPI19	11221566		side turning insert		0	0,00	0,00		TT.MM.JJJJ
15	DBRNR 12			Turning head 75°		0	0,00	0,00		TT.MM.JJJJ
16	DBRNR 12			Turning head 75°		0	0,00	0,00		TT.MM.JJJJ
17	HSA-763-DCLNR-12	11562396		Cutting head Maxlock D		0	0,00	0,00		TT.MM.JJJJ
18	AJ203 DCLNR 12	11224892		Maxlock D internal turning tool		0	0,00	0,00		TT.MM.JJJJ

Seite 2 von 5



3	
308268	73
357187	72

4	
4209	72, 73
4771	74, 75

5	
59433	74, 75
59434	72, 73
59439	72, 73
59441	74, 75
59448	72, 73

8	
86178	72, 73

C	
CNMG.. -M70	52, 53
CNMG.. -TMQ	52, 53
CNMM.. -R28	38, 39, 52, 53
CNMM.. -R58	38, 39
CNMM.. -R88	38, 39, 52, 53
CNMX.. -SN	76, 77
CTCK120	67
CTCP115	25, 45, 67
CTCP125	25, 45, 67
CTCP135	45

D	
DNMG.. -M70	54, 55
DNMG.. -TMQ	54, 55
DNMM.. -R28	54, 55
DNMM.. -R58	54, 55

L	
LINUX19.. -R70	80, 81
LINUX19.. -R74	80, 81
LINUX30.. -R70	80, 81
LINUX30.. -R74	80, 81

R	
RCGT.. -SM	56, 57
RCMT.. -M23	34, 35, 56, 57
RCMT.. -R23	34, 35
RCMT.. -SM	34, 35, 56, 57
RCMX.. -R53	34, 35
RCMX.. -R83	34, 35
RK.. -19L	74, 75
RK.. -19R	74, 75

RK.. -21L	73
RK.. -21R	73
RK.. -30L	74
RK.. -30R	74
RK.. -C19L	72
RK.. -C19R	72

S	
SNMG.. -M70	58, 59
SNMG.. -R70	78, 79
SNMG.. -R71	78, 79
SNMM.. -R28	36, 37, 58, 59
SNMM.. -R58	36, 37, 58, 59
SNMM.. -R88	36, 37, 58, 59
SNMT.. -R88	58, 59

T	
TNMG.. -M70	60, 61
TNMM.. -R28	60, 61
TNMM.. -R58	60, 61

Headquarters:

CERATIZIT S.A.
LU-8232 Mamer
T. +352 31 20 85-1
E. info@ceratizit.com

www.ceratizit.com

Austria

CERATIZIT Austria GmbH
AT-6600 Reutte
T. +43 5672 200-0
E. info.austria@ceratizit.com

Brazil

CERATIZIT América Latina Ltda.
BR-06453-002 Barueri, São Paulo
T. +55 11 4133 2300
E. info.americalatina@ceratizit.com

Bulgaria

CERATIZIT Bulgaria AG
BG-5301 Gabrovo
T. +359 66 812 206
E. info.bulgaria@ceratizit.com

China

CB-CERATIZIT Tianjin
CN-300384 Tianjin
T. +86 22 5810 7000

Czech Republic / Slovak Republic

CERATIZIT Office Czech Republic
CZ-594 01 Velké Meziříčí
T. +420 566 520 341
E. info.czechrepublic@ceratizit.com

France / Luxembourg / Belgium

CERATIZIT Luxembourg S.à r.l.
LU-8232 Mamer
T. +352 31 20 85-1
E. info@ceratizit.com

Germany

CERATIZIT Deutschland GmbH
DE-72186 Empfingen
T. +49 7485 99802 0
E. info.deutschland@ceratizit.com

Great Britain

Ceratizit UK & IRELAND LTD.
UK-Sheffield S9 1XU
Toll Free 0800 048 4877 / 4878
T. +44 1925 261 161
E. info.uk@ceratizit.com

Hungary

CERATIZIT Office Hungary
HU-1138 Budapest
T. +36 1 437 0930
E. info.hungary@ceratizit.com

India

CERATIZIT India Pvt. Ltd.
IN-Bengaluru 560099
T. +91 80 4043 1262
E. ctindia.south@ceratizit.com

CERATIZIT India Pvt. Ltd.
IN-Chennai 600037
T. +91 44 4269 4350
E. ctindia.south@ceratizit.com

CERATIZIT India Pvt. Ltd.
IN-Coimbatore 641009
T. +91 4224 273 373
E. ctindia.south@ceratizit.com

CERATIZIT India Pvt. Ltd.
IN-Gurgaon 122002
T. +91 124 4018 481
E. ctindia.north@ceratizit.com

CERATIZIT India Pvt. Ltd.
IN-Pune 411018
T. +91 20 6529 0628
E. ctindia.west@ceratizit.com

Indonesia

CB-CERATIZIT Indonesia
ID-17530 Bekasi
T. +62-21-2961-2351

Italy

CERATIZIT Italia S.p.A.
IT-22040 Alserio (CO)
T. +39 031 6349 211
E. info.italia@ceratizit.com

Mexico

CERATIZIT México, S.A. de C.V.
MX-76040 Querétaro, QRO
T. +52 442 225 9173
E. info.mexico@ceratizit.com

Netherlands

CERATIZIT Nederland B.V.
NL-4707 AT Roosendaal
T. +31 165 55 08 00
E. info.nederland@ceratizit.com

Poland

CERATIZIT Office Poland
PL-30-443 Kraków
T. +48 12 252 8591
E. info.polska@ceratizit.com

Spain / Portugal

CERATIZIT Ibérica S.L.
ES-28031 Madrid
T. +34 91 351 0609
E. info.iberica@ceratizit.com

Taiwan

CB-CERATIZIT Tamsui
TW-25152-Tamsui
T. +886 2 2622 1668

Turkey

CERATIZIT Turkey
TR-34870 Kartal, Istanbul
T. +90 216 353 66 43
E. info.turkey@ceratizit.com

USA / Canada

CERATIZIT USA, Inc.
US-Warren, MI 48089-1833
Toll free +1-800-783-2280
T. +1-586-759-2280
E. info.usa@ceratizit.com

We reserve the right to make technical changes for improvement of the product.

